

ASSEMBLY

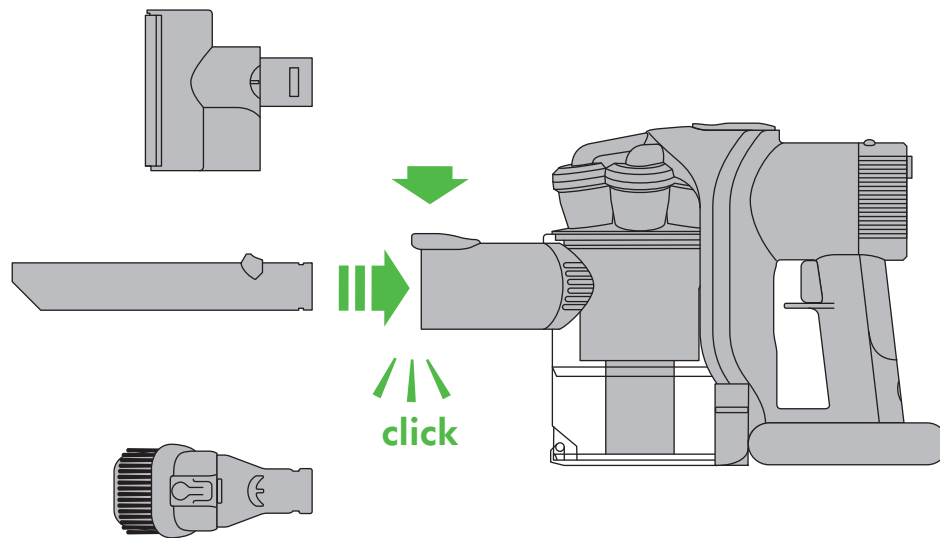

1
month

WASH FILTER

Wash filter with cold water at least every month.

REGISTER YOUR FREE 2 YEAR GUARANTEE TODAY

5.5 hrs

- Charging.
- Fully charged.
- Not charging – check battery.
- Not charging – too cold/too hot.

DYSON CUSTOMER CARE

THANK YOU FOR CHOOSING TO BUY A DYSON APPLIANCE

After registering your free 2 year guarantee, your Dyson appliance will be covered for parts and labour for 2 years from the date of purchase, subject to the terms of the guarantee.

If you have any questions about your Dyson appliance, call the Dyson Helpline with your serial number and details of where/when you bought the appliance.

Most questions can be solved over the phone by one of our trained Dyson Helpline staff.

Alternatively, visit www.dyson.co.uk/support (UK) or www.dyson.ie/support (ROI) for online help, general tips and useful information about Dyson.

Your serial number can be found on your rating plate which is on the main body of the appliance behind the filter.

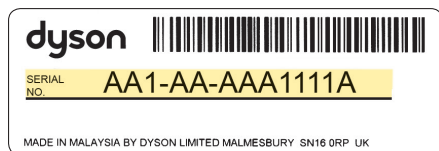
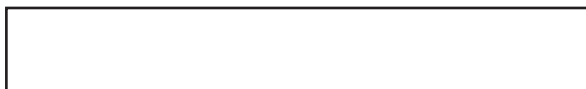

This illustration is for example purposes only.

DYSON CONTACT DETAILS

UK:

Website: www.dyson.co.uk/support

Dyson Helpline: UK: 0800 298 0298

Open Monday-Friday 8am-8pm

Saturday and Sunday 8am-6pm

7 days a week.

Email: askdyson@dyson.co.uk

Address: Dyson Limited, Tetbury Hill, Malmesbury, Wiltshire SN16 0RP England.

ROI:

Website: www.dyson.ie/support

Dyson Helpline: ROI: 01 475 7109

Open Monday-Friday 8am-8pm

Saturday and Sunday 8am-6pm

7 days a week.

Email: askdyson@dyson.co.uk

Address: Unit 10, Grants Lane, Greenogue Business Park, Rathcoole, Dublin 24.

3 EASY WAYS TO REGISTER YOUR FREE 2 YEAR GUARANTEE



REGISTER ONLINE

Visit our website to register your full parts and labour guarantee online.

www.dyson.co.uk/register
www.dyson.ie/register



REGISTER BY PHONE

Call our dedicated Helpline
Open Monday-Friday 8am-8pm
Saturday and Sunday 8am-6pm
7 days a week.

UK 0800 298 0298
ROI 01 475 7109



REGISTER BY MAIL

Complete and return the form to Dyson in the envelope supplied.

IMPORTANT SAFETY INSTRUCTIONS

BEFORE USING THIS APPLIANCE READ ALL INSTRUCTIONS AND CAUTIONARY MARKINGS IN THIS MANUAL AND ON THE APPLIANCE

When using an electrical appliance, basic precautions should always be followed, including the following:

WARNING

TO REDUCE THE RISK OF FIRE, ELECTRIC SHOCK, OR INJURY:

THESE WARNINGS APPLY TO THE APPLIANCE, ALL TOOLS AND ACCESSORIES, AND ALSO WHERE APPLICABLE TO ANY CHARGER OR MAINS ADAPTOR.

1. This Dyson appliance is not intended for use by young children or infirm persons with reduced physical, sensory or reasoning capabilities, or lack of experience and knowledge, unless they have been given supervision or instruction by a responsible person concerning use of the appliance to ensure that they can use it safely.
2. Do not allow to be used as a toy. Close attention is necessary when used by or near children. Children should be supervised to ensure that they do not play with the appliance.
3. Use only as described in this Dyson Operating Manual. Do not carry out any maintenance other than that shown in this manual, or advised by the Dyson Helpline.
4. Suitable for dry locations ONLY. Do not use outdoors or on wet surfaces.
5. Do not handle any part of the plug or appliance with wet hands.
6. Do not use with a damaged cable or plug. If the supply cable is damaged it must be replaced by Dyson, its service agent or similarly qualified persons in order to avoid a hazard.
7. If the appliance is not working as it should, has received a sharp blow, has been dropped, damaged, left outdoors, or dropped into water, do not use and contact the Dyson Helpline.
8. Contact the Dyson Helpline when service or repair is required. Do not disassemble the appliance as incorrect reassembly may result in an electric shock or fire.
9. Do not stretch the cable or place the cable under strain. Keep the cable away from heated surfaces. Do not close a door on the cable, or pull the cable around sharp edges or corners. Arrange the cable away from traffic areas and where it will not be stepped on or tripped over. Do not run over the cable.
10. Do not unplug by pulling on the cable. To unplug, grasp the plug, not the cable. The use of an extension cable is not recommended.
11. Do not use to pick up water.
12. Do not use to pick up flammable or combustible liquids, such as petrol, or use in areas where they or their vapours may be present.
13. Do not pick up anything that is burning or smoking, such as cigarettes, matches, or hot ashes.
14. Keep hair, loose clothing, fingers, and all parts of the body away from openings and moving parts. Do not point the hose, wand or tools at your eyes or ears or put them in your mouth.
15. Do not put any object into openings. Do not use with any opening blocked; keep free of dust, lint, hair, and anything that may reduce airflow.
16. Use only Dyson recommended accessories and replacement parts.
17. Do not use without the clear bin and filter in place.
18. Unplug when not in use for extended periods and before maintenance or servicing.
19. Use extra care when cleaning on stairs.
20. Do not install, charge or use this appliance outdoors, in a bathroom or within 3 metres (10 feet) of a pool. Do not use on wet surfaces and do not expose to moisture, rain or snow.
21. Use only Dyson chargers for charging this Dyson appliance. Use only Dyson batteries: other types of batteries may burst causing injury to persons and damage.
22. Do not incinerate this appliance even if it is severely damaged. The battery may explode in a fire.
23. Always turn 'OFF' the appliance before connecting or disconnecting the motorised brush bar.

READ AND SAVE THESE INSTRUCTIONS

THIS DYSON APPLIANCE IS INTENDED FOR HOUSEHOLD USE ONLY



Do not use near naked flames.



Do not store near heat source.



Do not pick up water or liquids.



Do not pick up burning objects.



Do not put hands near the brush bar when the appliance is in use.

Looking for blockages

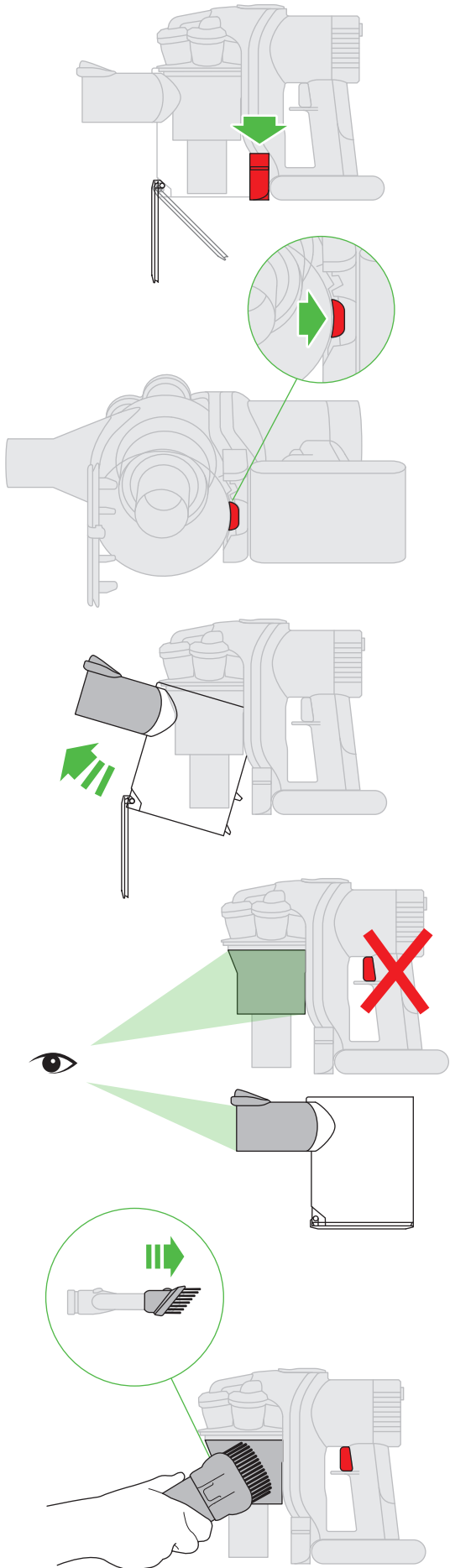
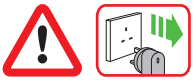

Power

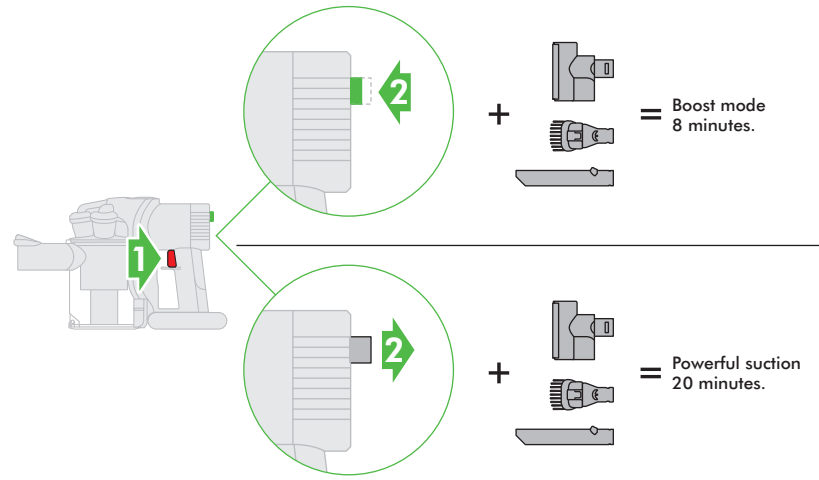

+ = Boost mode
8 minutes.

+ = Powerful suction
20 minutes.

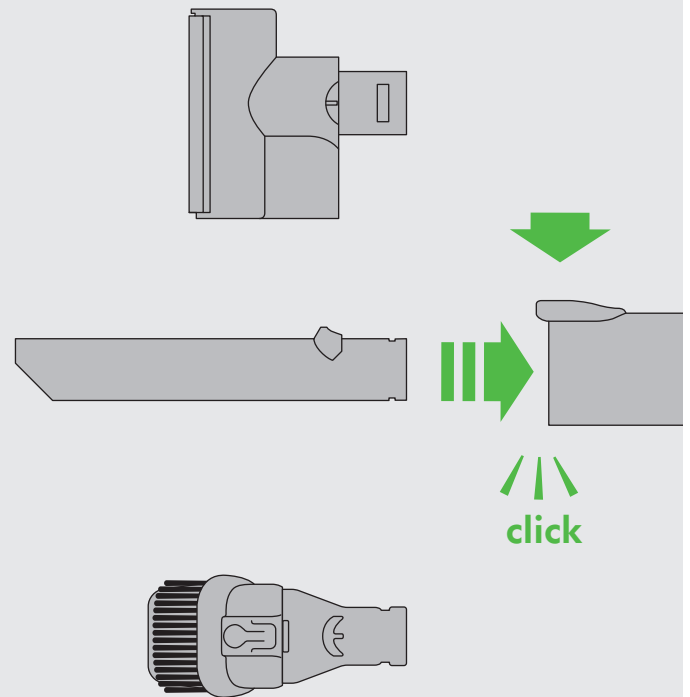

Combination tool

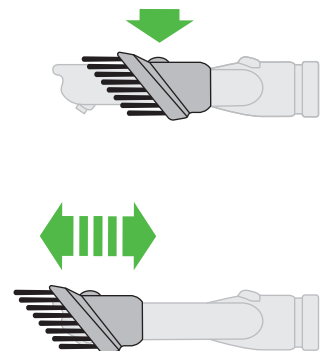

Diagnostics

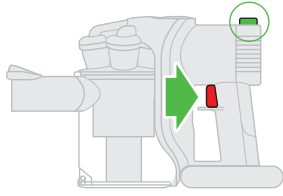

Less than one minute of charge remaining/fully discharged



Too cold/too hot – do not use

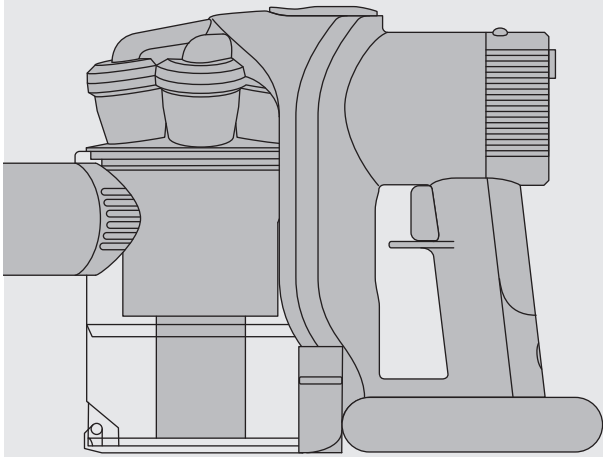

Charging

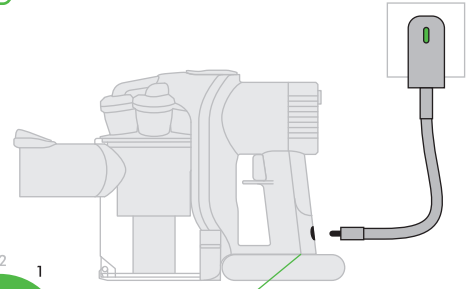

Charging



Fully charged



Not charging – check battery



Not charging – too cold/too hot

Clearing brush bar obstructions



1

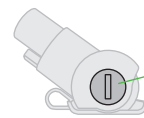

2

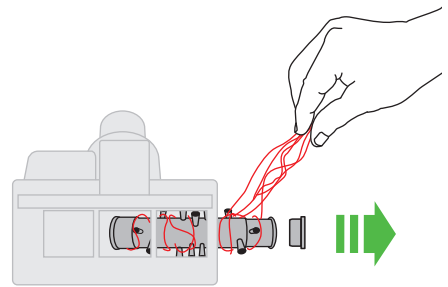

3

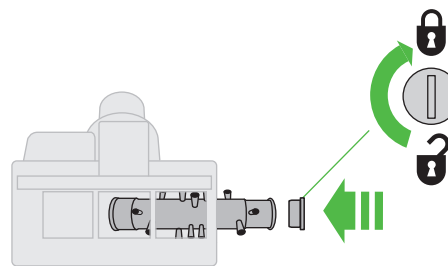

Emptying

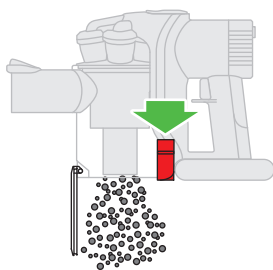
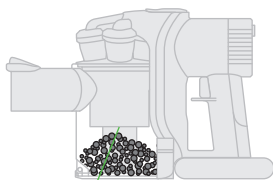

IMPORTANT!

WASH FILTER



1
month

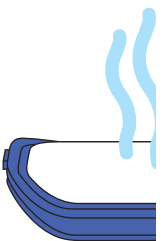
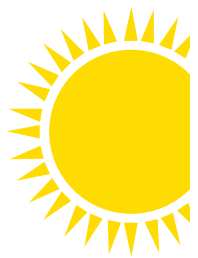
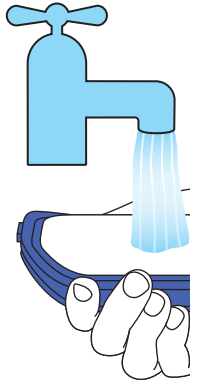
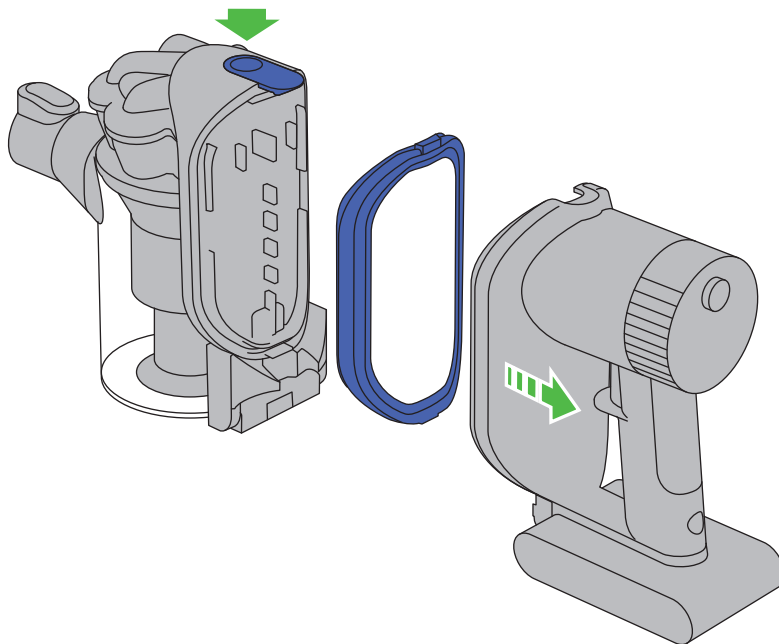
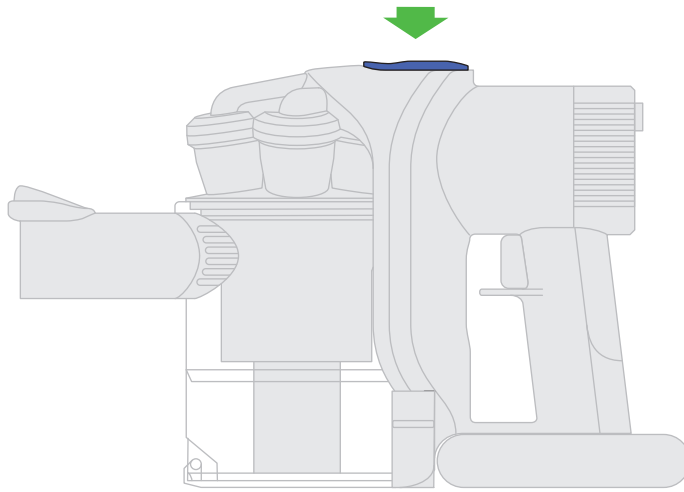

Wash filter with cold water at least every month.

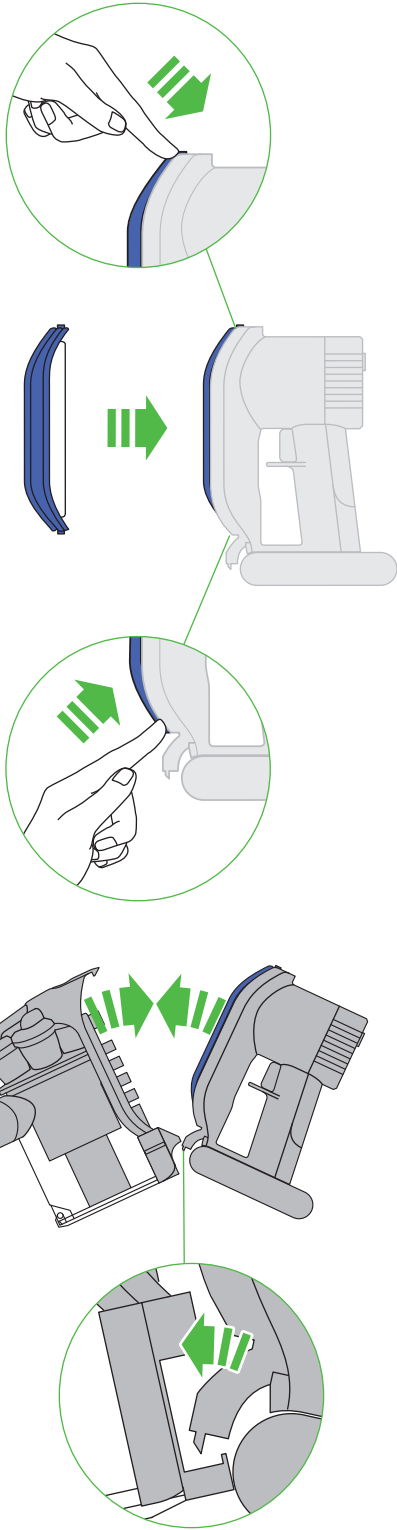
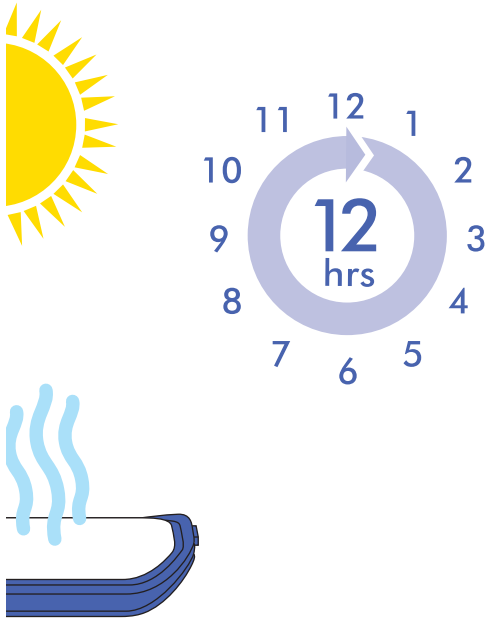
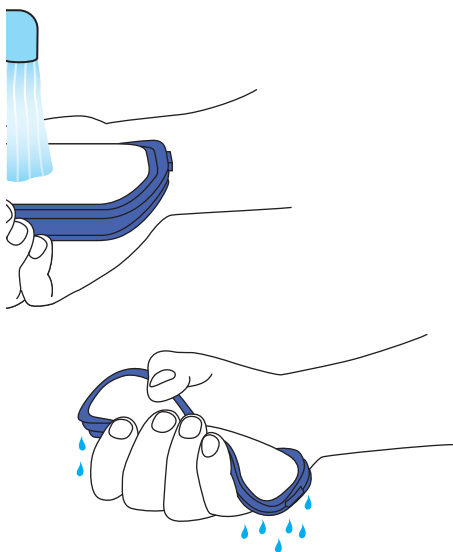
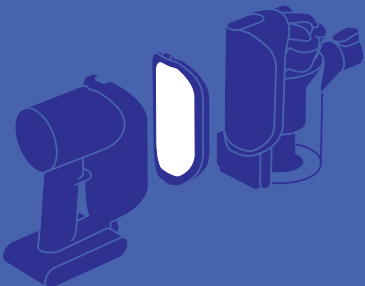

USING YOUR DYSON APPLIANCE

PLEASE READ THE 'IMPORTANT SAFETY INSTRUCTIONS' IN THIS DYSON OPERATING MANUAL BEFORE PROCEEDING.

OPERATION

- Do not use outdoors or on wet surfaces or to vacuum water or other liquids – electric shock could occur.
- Ensure the appliance remains upright in use and in storage. Dirt and debris may be released if it is turned upside down.
- Do not operate while checking for blockages.
- For domestic indoor and car use only. Do not use it whilst the car is in motion or while driving.
- To operate the boost mode, hold the trigger down and press the boost button. The boost button will light up.
- To switch off boost mode, hold the trigger down and press the boost button again. Note: The appliance will retain the last used mode. So if you use it in boost mode and do not disengage it, the appliance will operate in boost mode when it is next used until you depress the boost button to disengage it.
- To watch a short online video visit:
UK – www.dyson.co.uk/dc43hgettingstarted
ROI – www.dyson.ie/dc43hgettingstarted

CARPETS OR HARD FLOORS

- Before vacuuming your flooring, rugs and carpets, check the manufacturer's recommended cleaning instructions.
- The brush bar on the appliance can damage certain carpet types and floors. Some carpets will fuzz if a rotating brush bar is used when vacuuming. If this happens, we recommend vacuuming without the motorised floor tool and consulting with your flooring manufacturer.
- Before vacuuming highly polished floors, such as wood or lino, first check that the underside of the floor tool and its brushes are free from foreign objects that could cause marking.

LOOKING AFTER YOUR DYSON APPLIANCE

- Do not carry out any maintenance or repair work other than that shown in this Dyson Operating Manual, or advised by the Dyson Helpline.
- Only use parts recommended by Dyson. If you do not this could invalidate your guarantee.
- Store the appliance indoors. Do not use or store it below 3°C (37°F). Ensure the appliance is at room temperature before operating.
- Clean the appliance only with a dry cloth. Do not use any lubricants, cleaning agents, polishes or air fresheners on any part of the appliance.

VACUUMING

- Do not use without the clear bin and filter in place.
- Fine dirt such as plaster dust or flour should only be vacuumed in very small amounts.
- Do not use the appliance to pick up sharp hard objects, small toys, pins, paper clips, etc. They may damage the appliance.
- When vacuuming, certain carpets may generate small static charges in the clear bin or nozzle. These are harmless and are not associated with the mains electricity supply. To minimise any effect from this, do not put your hand or insert any object into the clear bin unless you have first emptied it and cleaned it with a damp cloth (see 'Cleaning the clear bin').
- Use extra care when cleaning on stairs.
- Do not rest the appliance on chairs, tables, etc.
- Do not press down on the nozzle with excessive force when using the appliance as this may cause damage.
- Do not leave the cleaner head in one place on delicate floors.
- On waxed floors the movement of the cleaner head may create an uneven lustre. If this happens, wipe with a damp cloth, polish the area with wax, and wait for it to dry.

DIAGNOSTICS – MAIN BODY

When in use, trigger pressed:

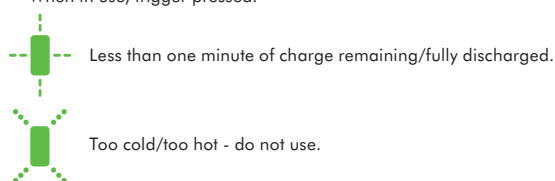

EMPTYING THE CLEAR BIN

- Empty as soon as the dirt reaches the level of the MAX mark – do not overfill.
- Ensure the appliance is disconnected from the charger before emptying the clear bin.
- To release the dirt, push the red button at the side of the clear bin as shown.
- To minimise dust/allergen contact when emptying, encase the clear bin tightly in a plastic bag and empty.
- Remove the clear bin carefully from the bag.
- Seal the bag tightly, dispose as normal.
- Close the clear bin base so it clicks into place and is secure.
- For a free fact sheet visit: www.dyson.co.uk/technology/allergy
- The British Allergy Foundation is a UK national charity with the aim of improving awareness, prevention and treatment of allergies. The British Allergy Foundation Seal of Approval is a UK registered trademark.

CLEANING THE CLEAR BIN

- Ensure the appliance is disconnected from the charger before removing the clear bin.
- Be careful not to pull the 'ON' trigger.
- To remove the clear bin, push the red button at the side of the clear bin as you would when emptying the clear bin. This will expose the red release button on the underside of the handle. Press this to release the clear bin.
- Remove the clear bin carefully.
- Clean the clear bin with a damp cloth only.
- Do not use detergents, polishes or air fresheners to clean the clear bin.
- Do not put the clear bin in a dishwasher.
- Clean the cyclone shroud with a dry cloth or dry brush to remove lint and dust.
- Ensure the clear bin is completely dry before replacing.
- To replace the clear bin, fit the tab on the rim of the cyclone shroud into the aperture on the inside of the top of the clear bin. Push the clear bin up and in. It will click into place.
- Close the base so it clicks into place and is secure.

WASHING YOUR FILTER

- Ensure the appliance is disconnected from the charger before removing the filter.
- Be careful not to pull the 'ON' trigger.
- Your appliance has one washable filter, located as shown.
- Press the blue 'Filter' button so you can remove the cyclone and clear bin unit.
- Check and wash the filter regularly according to instructions to maintain performance.
- The filter may require more frequent washing if vacuuming fine dust or if used mainly in 'Powerful suction' mode.
- Wash the filter with cold water only. Do not use detergents.
- Do not put the filter in a dishwasher, washing machine, tumble dryer, oven, microwave or near a naked flame.
- **IMPORTANT:** After washing please leave at least 12 hours to dry completely before refitting.
- Place the dry filter into the recess of the handle.
- Fit the base of the handle into the aperture on the base of the cyclone and clear bin unit. Push both halves together until the 'Filter' button engages and locks into place.
- To watch a short online video visit:
UK – www.dyson.co.uk/dc43hfilterwash
ROI – www.dyson.ie/dc43hfilterwash

LOOKING FOR BLOCKAGES

- Ensure the appliance is disconnected from the charger before looking for blockages.
- Be careful not to pull the 'ON' trigger.
- Do not operate while checking for blockages. Doing so could result in personal injury.
- Beware of sharp objects when checking for blockages.
- If you cannot clear an obstruction you may need to remove the brush bar. Use a coin to unlock the fastener marked with a padlock. Remove the obstruction. Replace the brush bar and secure it by tightening the fastener. Ensure it is fixed firmly before operating the appliance.
- Refit all parts securely before using.
- Clearing blockages is not covered by your guarantee.

BLOCKAGES – AUTOMATIC CUT-OUT

- This appliance is fitted with an automatic cut-out.
- If any part becomes blocked the appliance may automatically cut out.
- This will happen after the motor pulses a number of times (i.e switches on and off in quick succession).
- Leave to cool down before looking for blockages.
- Ensure the appliance is disconnected from the charger before looking for blockages. Failure to do so could result in personal injury.
- Clear any blockage before restarting.
- Refit all parts securely before using.
- Clearing blockages is not covered by your guarantee.

CHARGING AND STORING

- This appliance will switch 'OFF' if the battery temperature is below 3°C (37.4°F). This is designed to protect the motor and battery. Do not charge the appliance and then move it to an area with a temperature below 3°C (37.4°F) for storage purposes.
- To help prolong battery life, avoid recharging immediately after a full discharge. Allow to cool for a few minutes.
- Avoid using the appliance with the battery flush to a surface. This will help it run cooler and prolong battery run time and life.

DIAGNOSTICS – BATTERY

When charging battery:

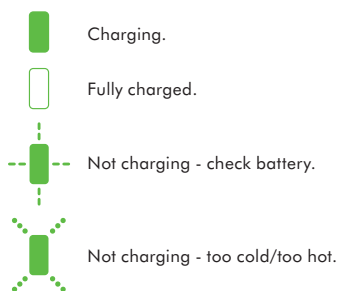

BATTERY SAFETY INSTRUCTIONS

- If the battery needs replacing please contact the Dyson Helpline.
- Use only Dyson chargers for charging this Dyson appliance.
- The battery is a sealed unit and under normal circumstances poses no safety concerns. In the unlikely event that liquid leaks from the battery do not touch the liquid and observe the following precautions:
- Skin contact – can cause irritation. Wash with soap and water.
- Inhalation – can cause respiratory irritation. Expose to fresh air and seek medical advice.
- Eye contact – can cause irritation. Immediately flush eyes thoroughly with water for at least 15 minutes. Seek medical attention.
- Disposal – wear gloves to handle the battery and dispose of immediately, following local ordinances or regulations.



CAUTION:

The battery used in this device may present a risk of fire or chemical burn if mistreated. Do not disassemble, short contacts, heat above 60°C (140°F), or incinerate. Replace battery with a Dyson battery only: use of any other battery may present a risk of fire or explosion. Dispose of used battery promptly. Keep away from children. Do not disassemble and do not dispose of in fire.

DISPOSAL INFORMATION

Dyson products are made from high grade recyclable materials. Please dispose of this product responsibly and recycle where possible.

- The battery should be removed from the product before it is disposed of.
- Dispose of, or recycle, the battery in accordance with local ordinances or regulations.

DYSON CUSTOMER CARE

THANK YOU FOR CHOOSING TO BUY A DYSON APPLIANCE

After registering your free 2 year guarantee, your Dyson appliance will be covered for parts and labour for 2 years from the date of purchase, subject to the terms of the guarantee.

If you have any questions about your Dyson appliance, call the Dyson Helpline with your serial number and details of where/when you bought the appliance. Most questions can be solved over the phone by one of our trained Dyson Helpline staff.

Alternatively, visit www.dyson.co.uk/support (UK) or www.dyson.ie/support (ROI) for online help, general tips and useful information about Dyson.

If your Dyson appliance needs a service, call the Dyson Helpline so we can discuss the available options. If your Dyson appliance is under guarantee, and the repair is covered, it will be repaired at no cost.

The serial number can be found on the rating plate which is on the main body of the appliance behind the filter.

PLEASE REGISTER AS A DYSON APPLIANCE OWNER

To help us ensure you receive prompt and efficient service, please register as a Dyson appliance owner. There are three ways to do this:

- Online at www.dyson.co.uk/register (UK) or www.dyson.ie/support (ROI).
 - Telephone the Dyson Helpline.
 - Complete the enclosed form and post it to us.
- This will confirm ownership of your Dyson appliance in the event of an insurance loss, and enable us to contact you if necessary.

LIMITED 2 YEAR GUARANTEE

TERMS AND CONDITIONS OF THE DYSON 2 YEAR LIMITED GUARANTEE

WHAT IS COVERED

The repair or replacement of your Dyson appliance (at Dyson's discretion) if it is found to be defective due to faulty materials, workmanship or function within 2 years of purchase or delivery (if any part is no longer available or out of manufacture Dyson will replace it with a functional replacement part).

Where this machine is sold outside of the EU, this guarantee will only be valid if the machine is used in the country in which it was sold.

Where the machine is sold within the EU, this guarantee will only be valid (i) if the machine is used in the country in which it was sold or (ii), if the machine is used in Austria, Belgium, France, Germany, Ireland, Italy, Netherlands, Spain or the United Kingdom and the same model as this machine is sold at the same voltage rating in the relevant country.

WHAT IS NOT COVERED

Dyson does not guarantee the repair or replacement of a product where a defect is the result of:

- Accidental damage.
- Faults caused by negligent use or care, misuse, neglect, careless operation or handling of the appliance which is not in accordance with the Dyson Operating Manual.
- Use of the appliance for anything other than normal domestic household purposes.
- Use of parts not assembled or installed in accordance with the instructions of Dyson.
- Use of parts and accessories which are not genuine Dyson components.
- Faulty installation (except where installed by Dyson).
- Repairs or alterations carried out by parties other than Dyson or its authorised agents.
- Blockages – please refer to the Dyson Operating Manual for details of how to look for and clear blockages.
- Normal wear and tear (e.g. fuse, etc.).
- Reduction in battery discharge time due to battery age or use.

If you are in any doubt as to what is covered by your guarantee, please contact Dyson.

SUMMARY OF COVER

- The guarantee becomes effective at the date of purchase (or the date of delivery if this is later).
- You must provide proof of (both the original and any subsequent) delivery/purchase before any work can be carried out on your Dyson appliance. Without this proof, any work carried out will be chargeable. Keep your receipt or delivery note.
- All work will be carried out by Dyson or its authorised agents.
- Any parts which are replaced will become the property of Dyson.
- The repair or replacement of your Dyson appliance under guarantee will not extend the period of guarantee.
- The guarantee provides benefits which are additional to and do not affect your statutory rights as a consumer.

ABOUT YOUR PRIVACY

- Your information will be held by Dyson Limited and its agents for promotional, marketing and servicing purposes.
- If your personal details change, if you change your mind about any of your marketing preferences or if you have any queries about how we use your information, please contact Dyson Limited.
- For more information on how we protect your privacy, please see our privacy policy on the Dyson website.

PRODUCT INFORMATION

Please note: Small details may vary from those shown.

IMPORTANT!

WASH FILTER



Wash filter with cold water at least every month.



Dyson Customer Care

After registering your free 2 year guarantee, your Dyson appliance will be covered for parts and labour for 2 years from the date of purchase, subject to the terms of the guarantee.

If you have any questions about your Dyson appliance, call the Dyson Helpline with your serial number and details of where/when you bought the appliance.

Most questions can be solved over the phone by one of our trained Dyson Helpline staff.

DYSON CONTACT DETAILS

UK:

Website: www.dyson.co.uk/support

Dyson Helpline: UK: 0800 298 0298

Open Monday-Friday 8am-8pm

Saturday and Sunday 8am-6pm

7 days a week.

Email: askdyson@dyson.co.uk

Address: Dyson Limited, Tetbury Hill, Malmesbury, Wiltshire SN16 0RP England.

ROI:

Website: www.dyson.ie/support

Dyson Helpline: ROI: 01 475 7109

Open Monday-Friday 8am-8pm

Saturday and Sunday 8am-6pm

7 days a week.

Email: askdyson@dyson.co.uk

Address: Unit 10, Grants Lane, Greenogue Business Park, Rathcoole, Dublin 24.





GUARANTEE FORM

Serial number

Date of purchase / / Country of purchase UK ROI

Title Surname

First name

Address

Postcode

email

Telephone Mobile

As a Dyson appliance owner, you can hear about Dyson inventions, services and products before anyone else. If it's okay to contact you, please let us know how we may do this.

By mail Yes No

By phone Yes No

By email Yes No

By text message Yes No

We sometimes ask other companies (such as market researchers) to contact owners on our behalf. We do this to get feedback on ideas or ask you to try new products and services. Would this be okay?

Yes No

3 EASY WAYS TO REGISTER YOUR FREE 2 YEAR GUARANTEE



REGISTER ONLINE

Visit our website to register your full parts and labour guarantee online.

www.dyson.co.uk/register
www.dyson.ie/register



REGISTER BY PHONE

Call our dedicated Helpline. Open Monday-Friday 8am-8pm Saturday and Sunday 8am-6pm 7 days a week.

UK 0800 298 0298
ROI 01 475 7109



REGISTER BY MAIL

Complete and return the form to Dyson in the envelope supplied.

