

dyson airblade

The fastest, most
hygienic hand dryers.



The Dyson Airblade Tap hand dryer installed in the washrooms of a leading F1 team.



Why do we put up with products that don't work properly?

In 1907, paper towels were introduced to washrooms. The electric hand dryer made its first appearance in 1948. But both have changed little since – they can still be expensive, unhygienic and harmful to the environment.

At Dyson, our engineers didn't think that was good enough. So in 2006, they put a century of poor performing hand drying methods to rest – with the invention of Airblade™ technology.

The problems with paper towels

Paper towels are expensive, have a high impact on the environment and cause extra washroom maintenance through mess and blockages.

And because dispensers are often found empty, leaving no way to dry hands, paper towels can create hygiene issues beyond the washroom.

Did you know?

Ensuring hands are dry is crucial for maintaining hygiene levels, as damp hands can spread up to 1,000 times more bacteria to the surfaces they touch.



The problems with other hand dryers

Warm air dryers

Warm air dryers are slow. Which means they're energy hungry, expensive to run and unhygienic.

Dry times can take up to 43 seconds, so many users give up before their hands are dry – risking increased spread of bacteria.

Jet dryers

Other jet dryers might look like a Dyson Airblade™ hand dryer, but when it comes to performance, there's no comparison. Thanks to weak motors, most other jet dryers can't generate the fast airflow needed to dry hands quickly. They can also lack the power required to draw the air through a HEPA filter.

So most other jet dryers aren't just slower than Airblade™ technology, they're less hygienic too.

Did you know?

Public health specialists NSF state that to be certified as hygienic, a hand dryer must dry hands in 15 seconds or less.



Have you ever looked inside a drain tank?

Some hand dryers collect waste water using drain tanks. But these are unhygienic – providing the perfect breeding ground for bacteria.

Drain tanks must be emptied and cleaned regularly – adding time and effort to the washroom maintenance process, and risking spillage of waste water during disposal.



Did you know?

In recent testing, Dyson microbiologists detected greater levels of bacteria in a drain tank than levels that can be found in the average household toilet.¹

¹ Sources: Dyson in-house testing, 2015; Scott et al., 2009; Medrano-Felix et al., 2010.

Dyson Airblade™ hand dryers work differently

Dyson digital motor V4

+ HEPA filter

+ Airblade™ technology

= The fastest,
most hygienic
hand dryers

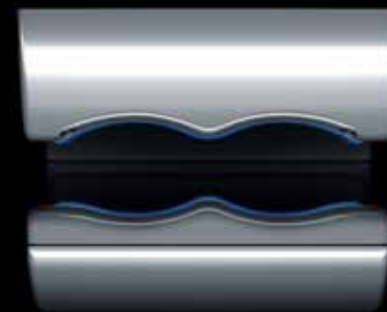
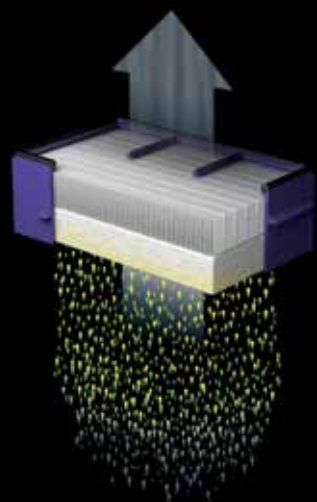

Dyson digital motor V4

Conventional motors are bulky, slow and can be inefficient. They also rely on carbon brushes, which wear out over time. The Dyson digital motor V4 is different. It's one of the world's smallest fully integrated 1600W motors, and instead of old-fashioned carbon brushes, it uses digital pulse technology to spin up to three times faster than a conventional motor.

HEPA filter

Bacteria and viruses in washrooms can cause colds, flu, sickness, diarrhoea or worse. Dyson Airblade™ hand dryers have HEPA filters installed as standard, which capture 99.9% of bacteria and viruses in the washroom air. So hands are dried with cleaner air, not dirty air.

Airblade™ technology

Every second, the Dyson digital motor V4 draws in up to 35 litres of air through a HEPA filter, and forces it through apertures up to 0.8 mm wide. The result – 430 mph sheets of filtered air that scrape water from hands, drying them quickly and hygienically.

**No other hand
dryer has this
technology**

Airblade™ technology has evolved

The latest Dyson Airblade™ hand dryers are powered by the Dyson digital motor V4 – one of the world's smallest, fully-integrated 1600W motors. Its small size and power density are what have made our latest hand dryer technology possible.

It means you'll now find a compact Dyson hand dryer that's just 10 centimetres deep – and one that's 50% quieter than the original but still dries hands in 10 seconds. You'll even find Airblade™ technology in a tap at the sink.

dyson airblade V

Concentrated Airblade™ technology. Slim and compact profile.

dyson airblade dB

Original Dyson Airblade™ hand dryer. Acoustically re-engineered to reduce noise by 50%.

dyson airblade tap

Airblade™ hand drying technology in a tap. Wash and dry hands at the sink.



Only Dyson Airblade™
hand dryers have
all these benefits.

The fastest.

Most hygienic.

Costs less to run.

Better for the environment.

5 year guarantee.

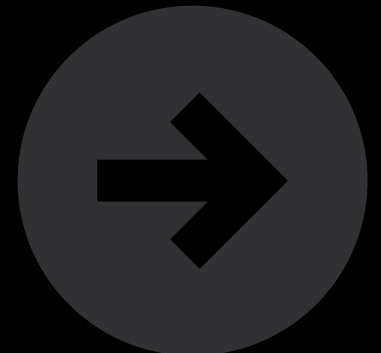

Other hand dryers are too slow

Testing based on NSF Protocol P335 shows that most other hand dryers are much slower than their manufacturers claim – with dry times based on drying hands without a HEPA filter. Many people give up when using a slow hand dryer. But damp hands can spread up to 1,000 times more bacteria than dry hands.



43 sec

No HEPA filter as standard



22 sec

Dyson hand dryers are the fastest

Testing based on NSF Protocol P335 proves that Dyson Airblade™ hand dryers are the fastest. Every second, up to 35 litres of air is forced through apertures up to 0.8 mm wide. The result – 430 mph sheets of air that scrape water from hands, drying them quickly and hygienically.



10 sec

HEPA filter as standard



10 sec

HEPA filter as standard



12 sec

HEPA filter as standard



NSF Protocol P335

For a more detailed overview of NSF Protocol P335 please see the reference section at the end of the brochure.

Airblade™ technology is the fastest and most hygienic

These are the reasons why:

↓ Dyson digital motor

+ HEPA filter

+ 10 second dry time

+ No drain tank

+ Antibacterial additive

+ No heating element

+ Touch-free operation

=

Only hand dryer globally accredited by NSF and HACCP International.



Damp hands can spread up to 1000 times more bacteria than dry hands.



Hygienically drying hands is as important as washing them

Bacteria and viruses deposited by hands onto surfaces can survive for several hours. When others touch these contaminated surfaces, they can be transferred. Damp hands can spread up to 1,000 times more bacteria than dry hands. It's why it's important that hands are dried properly.

The most hygienic hand dryer

Dyson Airblade™ hand dryers use HEPA filters. 99.9% of bacteria and viruses in the washroom air are captured. So hands are dried in 12 seconds or less using cleaner air, not dirty air. Both the Dyson Airblade V hand dryer and the Dyson Airblade dB hand dryer contain an antibacterial additive which can help prevent the growth of bacteria.

No drain tank

When you dry your hands with a Dyson Airblade V hand dryer or Dyson Airblade dB hand dryer, waste water is designed to drip onto the floor where it evaporates – so bacteria dry out and perish. But some hand dryers use drain tanks to collect waste water – providing the perfect breeding ground for bacteria. That's unhygienic.



Proven as hygienic

Bradford University

Conclusions:

Using a Dyson Airblade™ hand dryer reduces bacteria on washed hands by up to 40%.

Study background:

Conducted by the Bradford University Infection Group, the study's findings have been peer-reviewed by the academic community and published in the Journal of Applied Microbiology.

What they studied:

Bacteria removal by the Dyson Airblade™ hand dryer.

Campden BRI

Conclusions:

Using a Dyson Airblade™ hand dryer has no significant impact on bacteria levels in washroom air compared to paper towels.

Study background:

Conducted by independent food and drink research organisation Campden BRI, whose clients include hygiene-conscious global food businesses such as Cadbury, Pepsico, Danone, Coca-Cola, Heinz and Nestlé.

What they studied:

Bacteria counts in washroom air following use of Dyson Airblade™ hand dryers and paper towels.

University of Florida

Conclusions:

The surface of a Dyson Airblade™ hand dryer is no more contaminated than any other high-touch area in the washroom.

Study background:

Conducted by an epidemiologist from the Division of Infectious Diseases at the University of Florida's College of Medicine.

What they studied:

Bacterial contamination from Dyson Airblade™ hand dryers and other hand drying methods on high-touch areas in public washrooms – including paper towel dispensers, toilets, door knobs, toilet cubicle handles, flush controls, counter tops etc.

Funding into further independent studies will continue.



HACCP approved. Safe for the food sector.

The Dyson Airblade dB hand dryer and the Dyson Airblade Tap hand dryer have been approved for use in food preparation environments by HACCP International. They are the only hand dryers globally certified for use in the food and beverage industry.

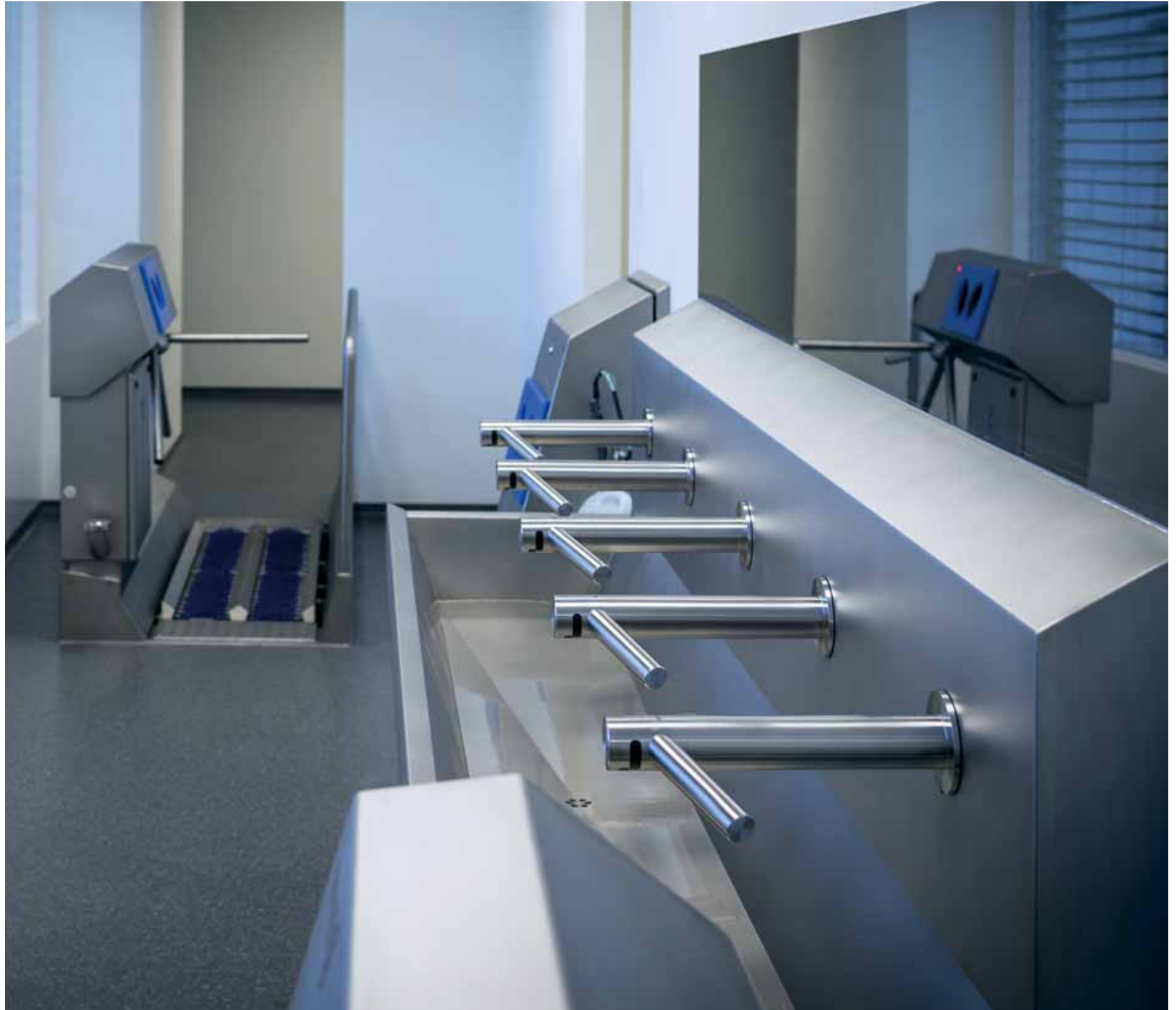

**Hygienic.
And costs less to run.**

With their slow dry times and lack of HEPA filtration, maintaining a hygienic washroom means avoiding other hand dryers altogether. But as you can see from the graph, paper towels are an expensive alternative. While paper towels can be just as hygienic as a Dyson Airblade™ hand dryer, their higher fixed running costs add up and up. And up.

£7,000

£5,000

£3,000

£1,000

YR 1

YR 2

YR 3

YR 4

YR 5



£7,300

Cost of paper towels after 5 years

88%¹

**SAVING OVER
PAPER TOWELS**

Cost of Dyson Airblade dB hand dryer after 5 years

£900



¹ For calculations visit dysonairblade.co.uk/calcs

Airblade™ technology is better for the environment

Higher impact on the environment

Dyson Airblade™ hand dryers produce up to 79% less CO₂ than some other hand dryers and up to 76% less than paper towels.¹



13.9g

CO₂ per dry¹



15.6g

CO₂ per dry¹



8.0g

CO₂ per dry¹

Low impact on the environment

Dyson Airblade™ hand dryers have a lower environmental impact across measures including carbon emissions and energy consumption.¹



3.4g

CO₂ per dry¹



3.6g

CO₂ per dry¹



4.0g

CO₂ per dry¹



¹ In collaboration with Carbon Trust, Dyson has produced a method to measure the environmental impact of electrical appliances and paper towels. The carbon calculations were produced using GaBi software provided by PE International, based on product use over 5 years and using the US as a representative country of use. Dry times for products were evaluated using DTM 769.

The only hand dryer certified by the Carbon Trust

Everything we make or use has a carbon footprint. It represents the total amount of carbon dioxide and other greenhouse gases generated during its life.

Working with the Carbon Trust, Dyson has measured the carbon footprint of the Dyson Airblade™ hand dryer range.

Every single component

All components inside the Dyson Airblade™ hand dryer were assessed. Materials and manufacture contribute 8% of total emissions.

Waterways vs. highways

Constant paper towel restocking relies on road transport. Dyson Airblade™ hand dryers use energy-efficient ships – representing less than 1% of total emissions.

Less energy = less carbon

Airblade™ technology has fast dry times and no energy-hungry heating elements. So it uses up to 80% less energy than warm air dryers.

End of life

With a 5 year guarantee, the Dyson Airblade™ hand dryer is built to last. Even so, many components are designed to be recyclable with negligible environmental impact.



The environmental impact of paper towels

From cutting down trees, through chemical processes to disposal – using paper towels has a significant impact on the environment.

Felling trees

Trees are a major source of pulp for virgin paper towel production.

Transportation

Once trees are felled they need to be transported from the forest to the mill.

Mix with water

Lots of water and energy are needed to make paper.

Pulping and bleaching

Chemicals are also used in the bleaching process.

Transportation

Paper towel dispensers need constant restocking.

Disposal

Most used paper towels cannot be recycled. They have to be disposed of. Used paper towels, packaging and bin liners end up in landfill or an incinerator.



5 year guarantee. Unrivalled service.

Test. Test. Test.

Dyson Airblade™ hand dryers are engineered to last. They have been repeatedly tested for durability and resilience to physical abuse. They have also been exposed to real-life environments to ensure that they can withstand the pressures of high usage.

Guarantee

Thanks to this rigorous testing regime, all factory parts on Dyson Airblade™ hand dryers are guaranteed against original defects in materials and workmanship for 5 years.

Aftersales support

But if anything does go wrong with your machine, we provide repair and maintenance support through Dyson service engineers and self-service spare parts. Reducing downtime and disruption to your facilities.

Dyson Airblade dB hand dryer
5 year parts, 1 year labour.

Dyson Airblade V hand dryer
5 years parts, easy self-service.

Dyson Airblade Tap hand dryer
5 year parts and labour.



dyson airblade V

Concentrated Airblade™ technology.
Slim and compact profile.

Takes up less space

The Dyson Airblade V hand dryer has a slim profile that protrudes just 10 centimetres from the wall. It's 60% smaller than the original Dyson Airblade™ hand dryer, but still dries hands in 10 seconds. Concentrated, not compromised.

Low maintenance

The Dyson Airblade V hand dryer can be mounted or removed from the wall quickly and easily thanks to its innovative backplate. This installation design means all Dyson Airblade V hand dryers come with a self service guarantee.

For full product details visit
www.dysonairblade.co.uk



AB
08

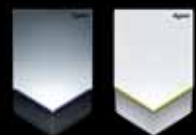

The View From the Shard

"The Dyson Airblade V hand dryers have a modern and sleek design that fits the general design of 'The View From the Shard' very well. Guests have told us they like the power and speed of the machines. We are very proud to be amongst the first to have these hand dryers."

Sandy Clark
Operations Director.



dyson airblade dB

Original Dyson Airblade™ hand dryer.

Acoustically re-engineered
to reduce noise by 50%.

Less washroom noise

The Dyson Airblade dB hand dryer has been acoustically re-engineered to reduce air rush noise and sound generated by the motor. It's 50% quieter than the original Dyson Airblade™ hand dryer, but still dries hands in 10 seconds.

Safe for the food sector

The Dyson Airblade dB hand dryer has been approved for use in food preparation environments by HACCP International. It is the only hands-in dryer globally certified for use in the food and beverage industry.

For full product details visit
www.dysonairblade.co.uk



AB
14



Gloucester Services

"Although we had a wide range of hand dryers to choose from, our sister station has had its Dyson Airblade™ hand dryers for over 5 years and they still only have positive things to say."

Joshua Jackson,
Facilities Manager.



dyson airblade tap

Airblade™ hand drying technology in a tap.

Wash and dry hands at the sink.

No waste water on the floor

With Airblade™ technology in a tap, hands can be dried at the sink in just 12 seconds. There's no need for users to move to a separate drying area, so no water is dripped on the floor.

Free up your washroom

Other hand drying methods take up valuable wall and floor space. With the Dyson Airblade Tap hand dryer, there's room for extra toilet cubicles and other facilities.

For full product details visit www.dysonairblade.co.uk



AB 09 Short AB 10 Long AB 11 Wall



Coca-Cola London Eye

"As an iconic global landmark, The London Eye needs to meet high expectations of quality – and that extends to our washrooms.

Installing the Dyson Airblade Tap hand dryer has allowed us to achieve this."

Davey Barrett,
Show Services Manager.



A different approach

It all began with James Dyson himself, who wondered if a vacuum cleaner really needed that bag. Later, Dyson engineers discovered hand dryers could dry hands without heat. And fans didn't have to use blades to cool you down.

At Dyson, we've been challenging the conventions of existing technology for over 20 years. Our engineers use this approach every day – helping us invent new machines that simply work better. And we're only just getting started.



Reference

NSF Protocol P335 criteria.

Dyson Airblade™ hand dryer specifications.

The only hand dryer certified hygienic

NSF certified

Dyson asked independent public health specialists NSF to define the criteria for a hygienic hand dryer. The result is NSF Protocol P335 – and Dyson Airblade™ hand dryers are the only hand dryers that meet every part of it.

Air filtration

Air used to dry hands must be HEPA filtered.

Unheated air

Warming moist bacteria increases their reproduction rate. Heated air can also remove beneficial oils from the skin.

Drying time

Hands must be dried in under 15 seconds. NSF have defined dry as 0.1g of residual moisture. Damp hands can spread up to 1,000 times more bacteria.







Touch-free operation

The hand dryer must start and stop without user contact.

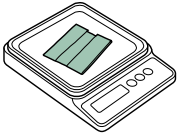
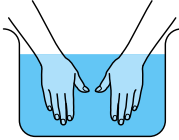

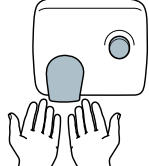
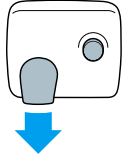
TESTED. CERTIFIED. HYGIENIC

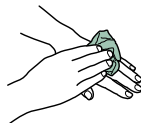
When are dry hands dry? Here's how they test it.

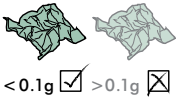
<p>1</p> 	<p>2</p> 	<p>3</p> 	<p>4</p> 
<p>Take three male and female volunteers.</p>	<p>Fold paper towel once, place on digital scales and record weight.</p>	<p>Place both hands in water container up to level of wrist crease for five seconds. Rub hands in the water to remove trapped air and bubbles.</p>	<p>Remove hands from container and let water drip from hands for five seconds.</p>
<p>5</p> 	<p>6</p> 	<p>7</p> 	<p>8</p> 
<p>Place hands under dryer 5cm from outlet. Dry hands according to manufacturer's instructions. If these instructions include rubbing then rub hands at a rate of two times per five seconds.</p>	<p>Once air begins to flow from dryer start to rub and dry hands. Commence drying process by rubbing palms together twice.</p>	<p>Continue drying process by rolling hands twice.</p>	<p>Continue drying process by interlocking and unlocking hands twice.</p>
<p>9</p> 	<p>10</p> 	<p>11</p> 	<p>12</p> 
<p>Remove excess water from hands (between fingers and wrist) with paper towel until hands feel dry. Roll towel into a ball and place on scales within five seconds.</p>	<p>Re-weigh the towel and record the weight.</p>	<p>Repeat the test for all six volunteers and calculate the mean dry time of the six tests.</p>	<p>The machine will be considered 'hygienic' only if the unit can effectively dry hands to less than 0.1g of residual moisture within 15 seconds. Anything over 0.1g of moisture means the product will be deemed unhygienic.</p>

Visit the website for full downloadable technical specifications.
www.dysonairblade.co.uk

REAR ELEVATION

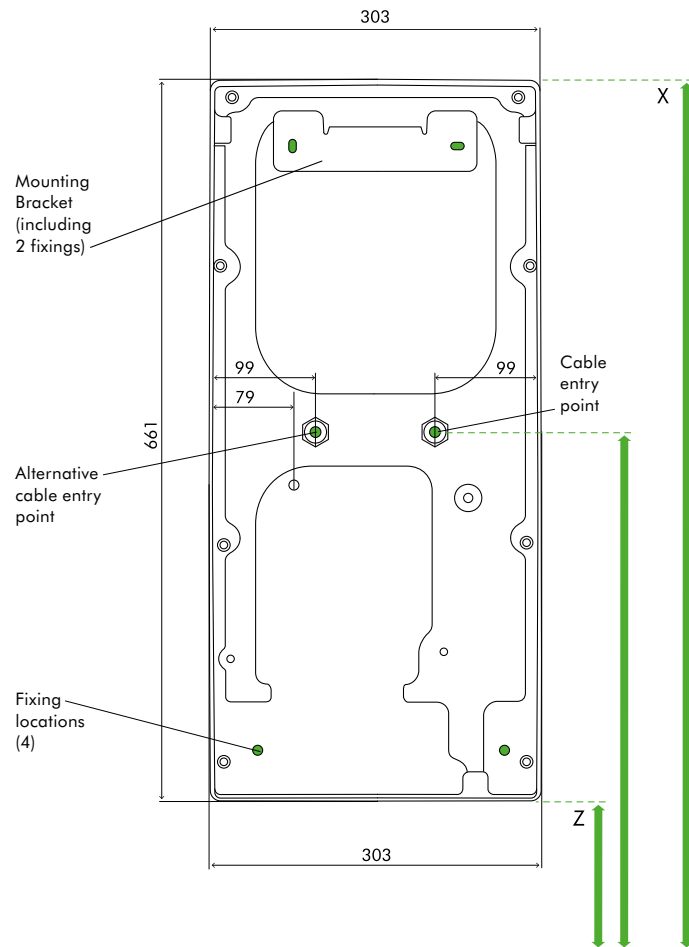

SIDE ELEVATION

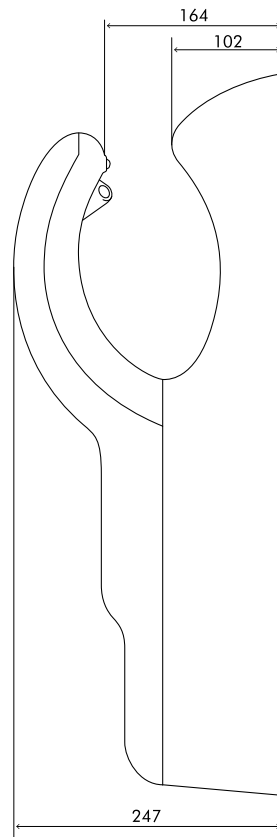

All dimensions shown in mm (+/-5mm)

FLOOR

Recommended installation heights from floor

Male	X 1050mm	Y 990mm	Z 390mm
Female	X 975mm	Y 915mm	Z 315mm
Child or disabled	X 875mm	Y 815mm	Z 215mm

Machine dimensions

Height 661mm Width 303mm Depth 247mm.

Visit the website for full downloadable technical specifications.
www.dysonairblade.co.uk

REAR ELEVATION

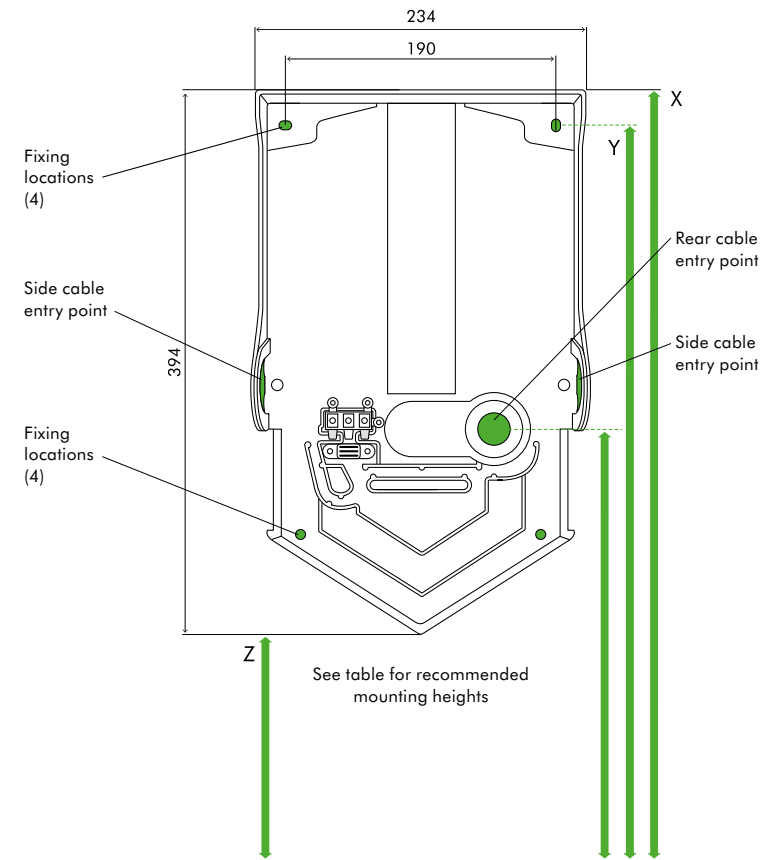

SIDE ELEVATION

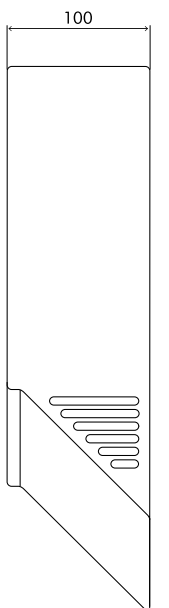

All dimensions shown in mm (+/-5mm)

FLOOR

Recommended installation heights from floor

Male	X 1324mm	Y 1300mm	Z 930mm
Female	X 1289mm	Y 1265mm	Z 895mm
Child or disabled	X 1074mm	Y 1050mm	Z 680mm

Machine dimensions

Height 394mm Width 234mm Depth 100mm.

Visit the website for full downloadable technical specifications, sink recommendations and pre-installation guides.
www.dysonairblade.co.uk

REAR ELEVATION

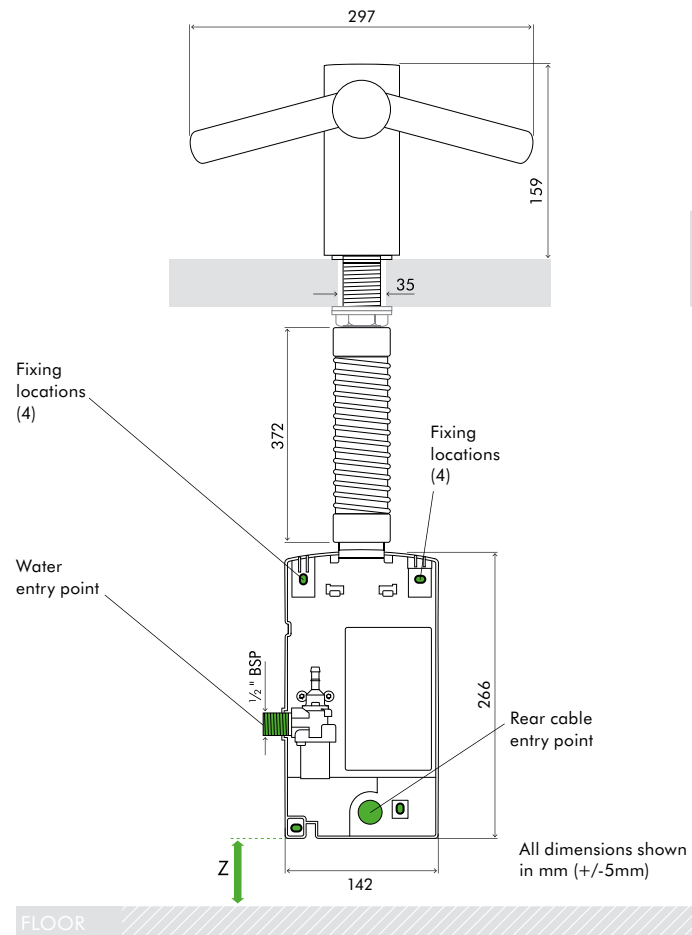

SIDE ELEVATION

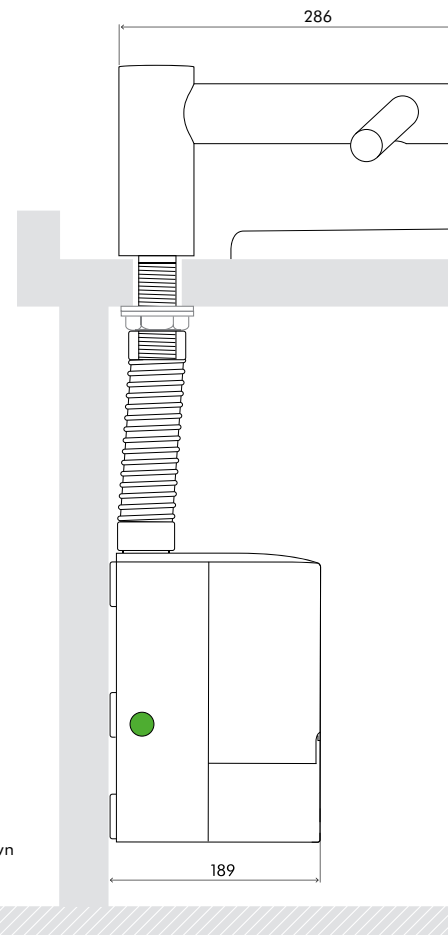

Tap dimensions

AB09 Height 159mm Width 297mm Depth 286mm

Motor bucket dimensions

AB09 Height 266mm Width 142mm Depth 189mm

Minimum clearance

Z 100mm clearance from floor.

REAR ELEVATION

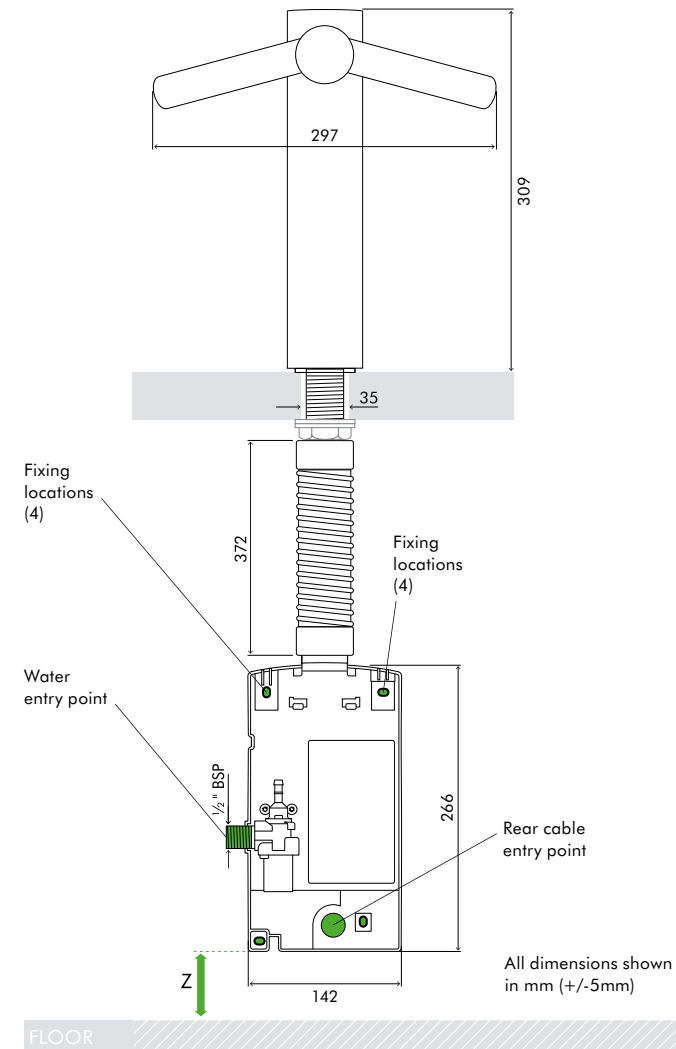

SIDE ELEVATION

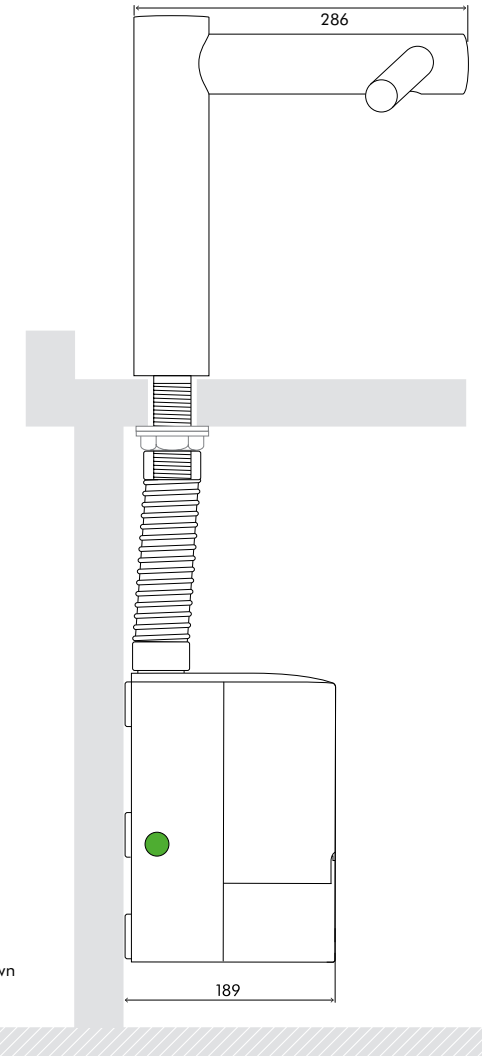

Tap dimensions

AB10 Height 309mm Width 297mm Depth 286mm

Motor bucket dimensions

AB10 Height 266mm Width 142mm Depth 189mm

Minimum clearance

Z 100mm clearance from floor.

To try the Dyson Airblade™
hand dryers or for more
information, please call:
0800 345 7788
www.dysonairblade.co.uk

SIDE ELEVATION

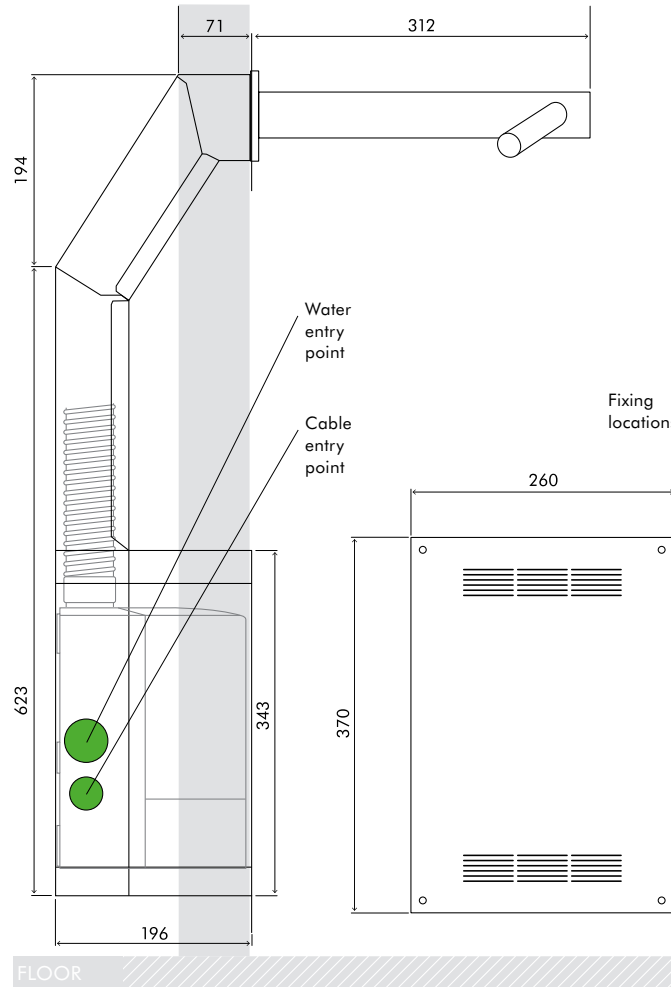

REAR ELEVATION

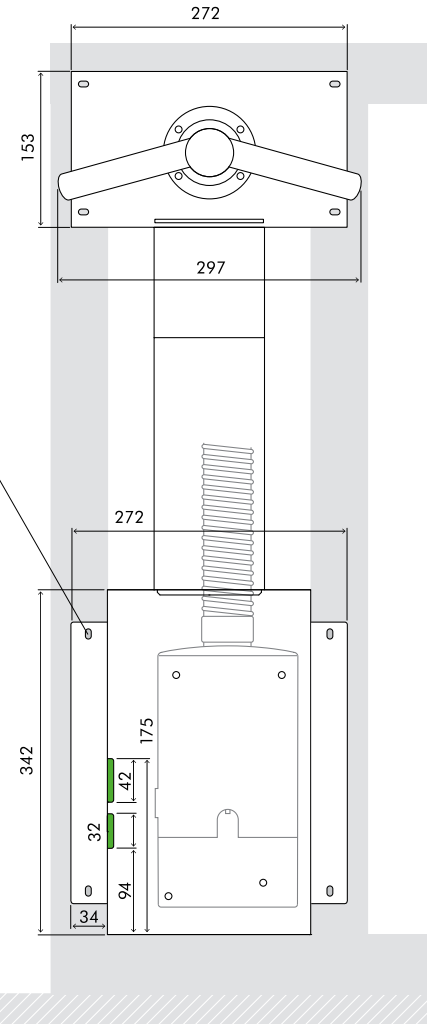

Tap dimensions

AB11 Length 312mm Width 297mm

Motor bucket dimensions

AB11 Height 266mm Width 142mm Depth 189mm

dyson airblade



The Carbon label is a trade mark of the Carbon Trust.
The NSF logo is the registered trade mark of NSF International. HACCP International non-food certification mark is the registered trademark of HACCP International.
HACCP International have certified Dyson products based on their recommended installation and operating conditions. Licensed by Dyson.