

ASSEMBLY

Do not allow the machine to twist at the blue tape. Allowing the machine to twist at the blue tape may result in accidental damage. Remove blue tape once the machine is assembled.

**Important!**

Remove clear film.

1

Align the arrows.

Then twist clockwise until it clicks and locks.

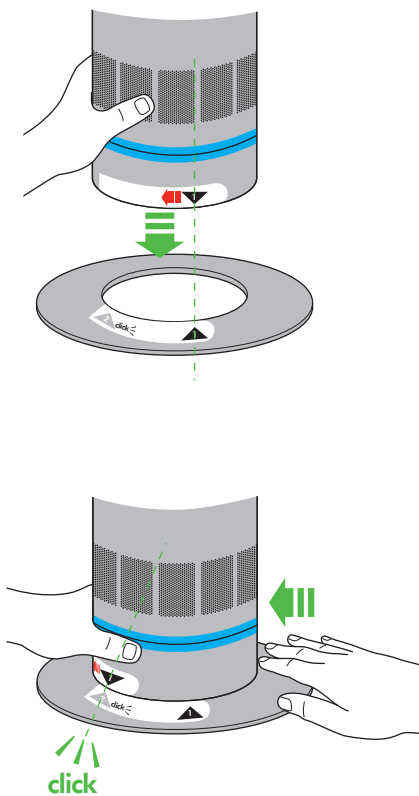

2

Lower the loop amplifier onto the base, aligning the arrows.

Once aligned, turn the loop amplifier clockwise to lock.

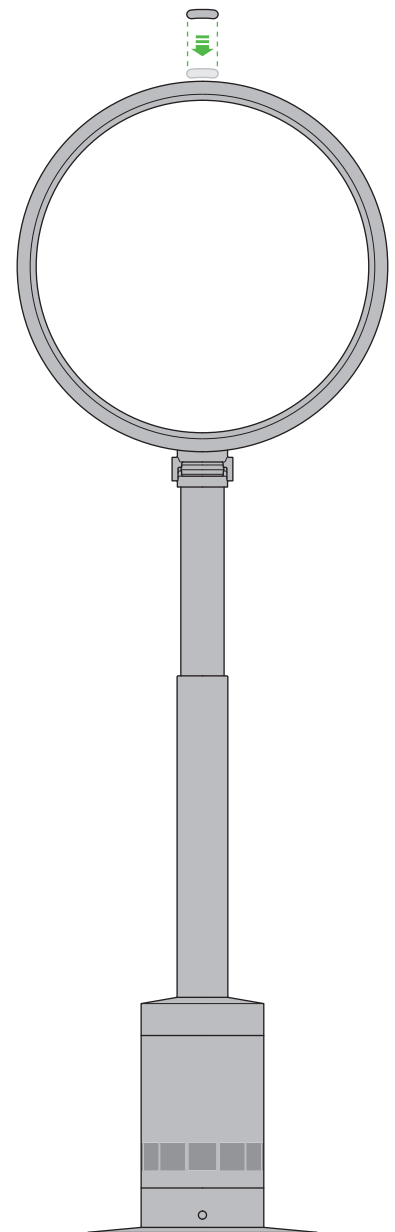
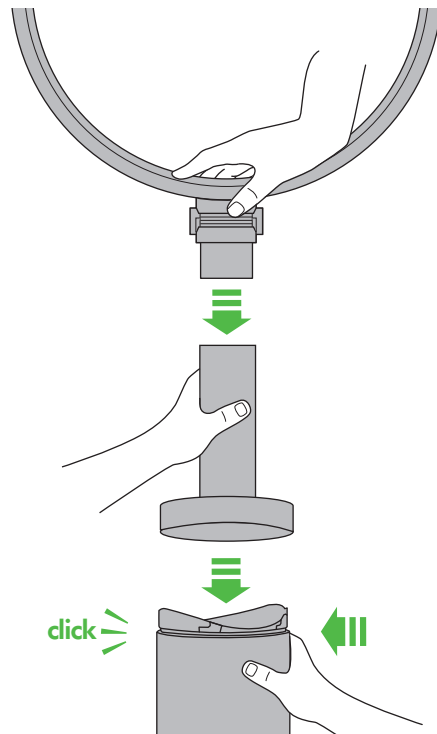

**REGISTER YOUR  
FREE 2 YEAR  
GUARANTEE TODAY**



**DYSON CUSTOMER CARE  
THANK YOU FOR CHOOSING  
TO BUY A DYSON APPLIANCE**

After registering your free 2 year guarantee, your Dyson appliance will be covered for parts and labour for 2 years from the date of purchase, subject to the terms of the guarantee. If you have any questions about your Dyson appliance, call the Dyson Helpline with your serial number and details of where/when you bought the appliance.

Most questions can be solved over the phone by one of our trained Dyson Helpline staff.

Your serial number can be found on your rating plate which is on the base of the appliance.

Alternatively, visit [www.dyson.co.uk/support](http://www.dyson.co.uk/support) (UK) or [www.dyson.ie/support](http://www.dyson.ie/support) (ROI) for online help, general tips and useful information about Dyson.

Note your serial number for future reference.



This illustration is for example purposes only.

**3 EASY WAYS TO REGISTER YOUR FREE 2 YEAR GUARANTEE**



**REGISTER  
ONLINE**

Visit our website to register your full parts and labour guarantee online.

[www.dyson.co.uk/register](http://www.dyson.co.uk/register)  
[www.dyson.ie/register](http://www.dyson.ie/register)



**REGISTER  
BY PHONE**

Call our dedicated Helpline.  
Open Monday to Friday 8am-8pm  
& Saturday and Sunday 8am-6pm.

**UK: 0800 298 0298**  
**ROI: 01 475 7109**



**REGISTER  
BY MAIL**

Complete and return the form to Dyson in the envelope supplied.

# IMPORTANT SAFETY INSTRUCTIONS

**BEFORE USING THIS APPLIANCE READ ALL INSTRUCTIONS AND CAUTIONARY MARKINGS IN THIS MANUAL AND ON THE APPLIANCE**

When using an electrical appliance, basic precautions should always be followed, including the following:

## **WARNING**

**THE FAN AND THE REMOTE CONTROL BOTH CONTAIN MAGNETS.**

1. Pacemakers and defibrillators may be affected by strong magnetic fields. If you or someone in your household has a pacemaker or defibrillator, avoid placing the remote control in a pocket or near to the device.
2. Credit cards and electronic storage media may also be affected by magnets and should be kept away from the remote control and the top of the appliance.

## **WARNING**

These warnings apply to the appliance, and also where applicable, to all tools, accessories, chargers or mains adaptors.

**TO REDUCE THE RISK OF FIRE, ELECTRIC SHOCK, OR INJURY:**

1. This Dyson appliance can be used by children aged from 8 years and above and persons with reduced physical, sensory or reasoning capabilities, or lack of experience and knowledge, only if they have been given supervision or instruction by a responsible person concerning use of the appliance in a safe way and understand the hazards involved. Cleaning and user maintenance shall not be made by children without supervision.
2. Ensure appliance is fully assembled in line with the instructions before use. Do not dismantle the appliance or use without the loop amplifier fitted.
3. Do not allow to be used as a toy. Close attention is necessary when used by or near children. Children should be supervised to ensure that they do not play with the appliance.
4. Use only as described in this Dyson Operating Manual. Do not carry out any maintenance other than that shown in this manual, or advised by the Dyson Helpline.
5. Suitable for dry location ONLY. Do not use outdoors or on wet surfaces and do not expose to water or rain.
6. Do not handle any part of the plug or appliance with wet hands.
7. Do not operate any appliance with a damaged cable or plug. Discard the appliance or return to an authorised service facility for examination and/or repair. If the supply cable is damaged it must be replaced by Dyson, its service agent or similarly qualified person in order to avoid a hazard.
8. If the appliance is not working as it should, has received a sharp blow, has been dropped, damaged, left outdoors, or dropped into water, do not use and contact the Dyson Helpline.
9. Do not stretch the cable or place the cable under strain. Keep cable away from heated surfaces.
10. Do not run cable under carpeting. Do not cover cable with throw rugs, runners or similar coverings. Arrange cable away from traffic area and where it will not be tripped over.
11. Do not unplug by pulling on the cable. To unplug, grasp the plug, not the cable. The use of an extension cable is not recommended.
12. Do not put any object into openings or the inlet grille. Do not use with any opening blocked; keep free of dust, lint, hair, and anything that may reduce airflow.
13. Do not use any cleaning agents or lubricants on this appliance. Unplug before cleaning or carrying out any maintenance.
14. Always carry the appliance by the base, do not carry it by the loop amplifier.
15. Turn off all controls before unplugging. Unplug before connecting any tool or accessory.
16. To avoid a tripping hazard wind the cable when not in use.
17. Do not use near furnaces, fireplaces, stoves or other high temperature heat sources.
18. Do not use in conjunction with or directly next to an air freshener or similar products.
19. Choking hazard - This remote control unit contains a small battery. Keep the remote control away from children and do not swallow the battery. If the battery is swallowed seek medical advice at once.

## READ AND SAVE THESE INSTRUCTIONS

**THIS DYSON APPLIANCE IS INTENDED FOR HOUSEHOLD USE ONLY**

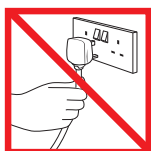

Do not pull on the cable.

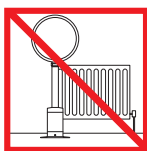

Do not store near heat sources.



Do not use near naked flames.



Do not carry by the loop amplifier.

## Control

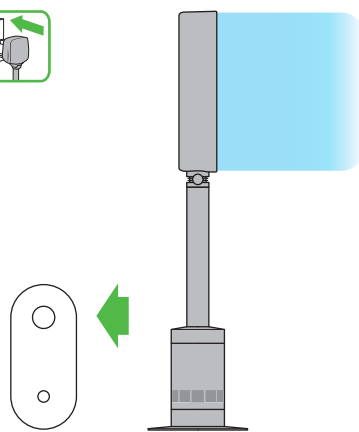
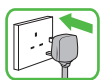
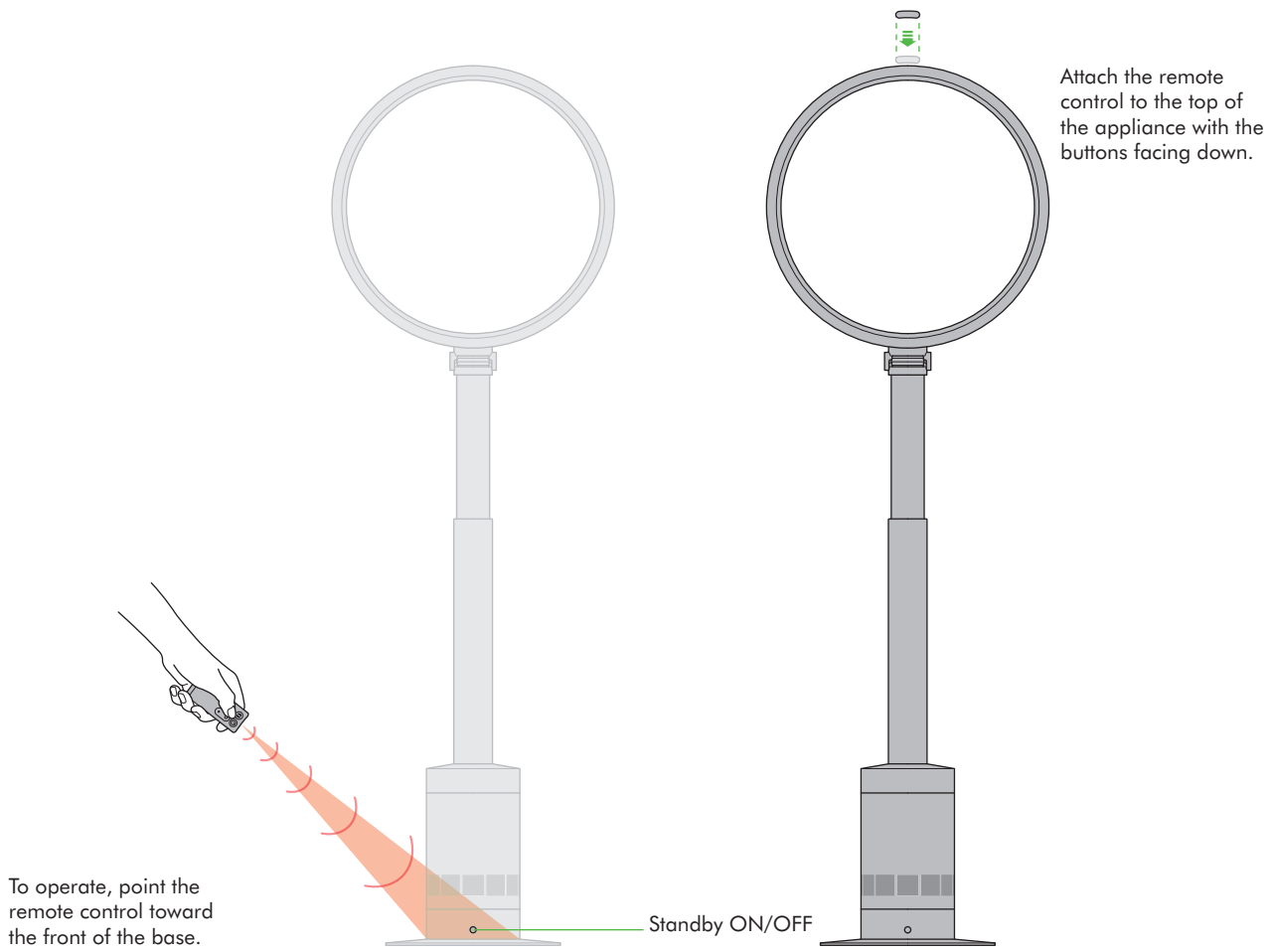

Select a high flow of air.

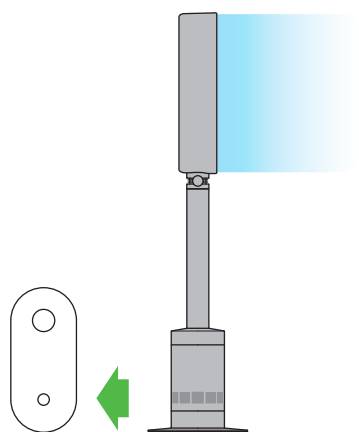

Select a low flow of air.

Standby ON/OFF

Oscillation ON/OFF

Airflow control

Sleep timer

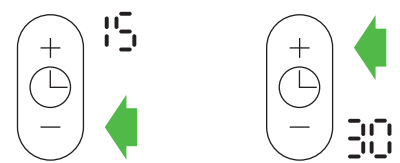

To set the sleep timer, select the desired time. When time reaches zero, the appliance will go into standby mode. To cancel, reduce the time until two dashes appear.



## Height adjustment

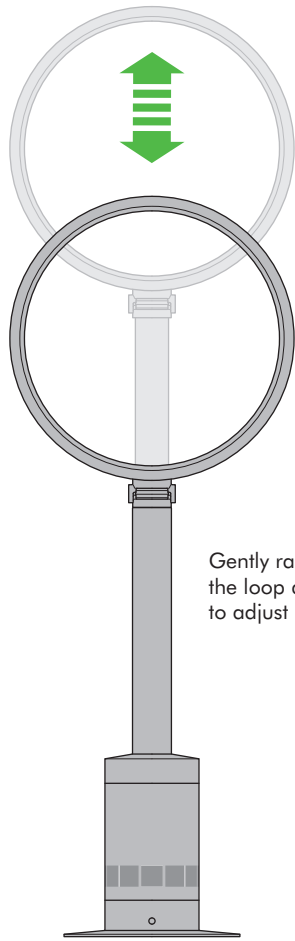

Gently raise or lower the loop amplifier to adjust height.

## Tilt function

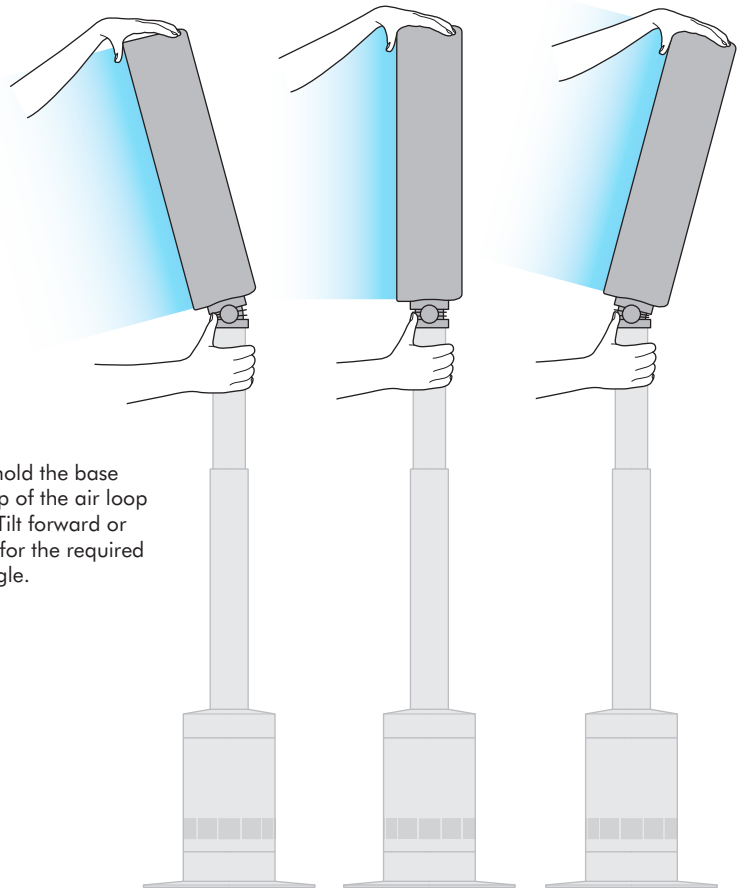

Carefully hold the base and the top of the air loop amplifier. Tilt forward or backward for the required airflow angle.

## Cleaning

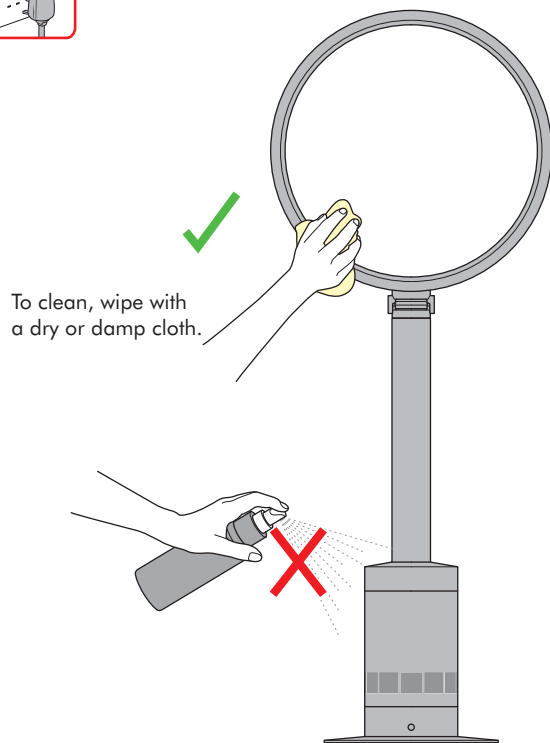
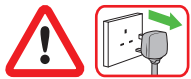

To clean, wipe with a dry or damp cloth.

Do not use detergents or polishes to clean the appliance.

## Clearing blockages

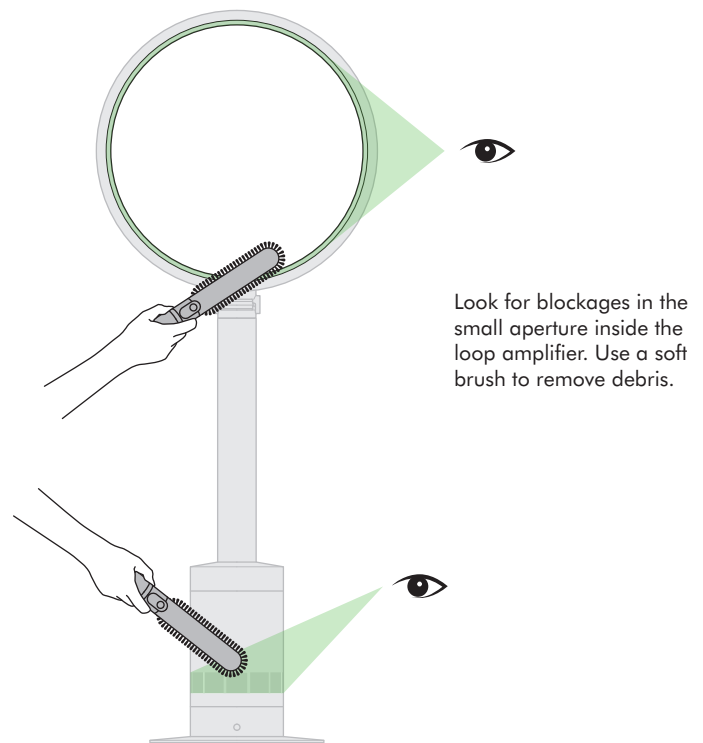

Look for blockages in the small aperture inside the loop amplifier. Use a soft brush to remove debris.

Look for blockages in the air inlet holes. Use a soft brush to remove debris.

## USING YOUR DYSON APPLIANCE

PLEASE READ THE 'IMPORTANT SAFETY INSTRUCTIONS' IN THIS DYSON OPERATING MANUAL BEFORE PROCEEDING.

## LOOKING AFTER YOUR DYSON APPLIANCE

- Do not carry out any maintenance or repair work other than that shown in this Dyson Operating Manual, or advised by the Dyson Helpline.
- Always disconnect the plug from the mains before inspecting for problems. If the appliance will not operate, first check the mains socket has electricity supply and that the plug is properly inserted into the socket.

## CONTROL WITHOUT REMOTE

- Press the Standby button on the appliance to turn ON/OFF.
- Press and hold the Standby button on the appliance to adjust the airflow. Airflow will increase to a maximum before decreasing.
- The oscillation function and sleep timer cannot be operated without the remote control.

## BATTERY REPLACEMENT



### CAUTION

- Unscrew the battery compartment on the remote control. Loosen the base and pull to remove the battery.
- Do not install backwards or short circuit the batteries.
- Do not attempt to dismantle or charge the batteries. Keep away from fire.
- Follow battery manufacturers' instructions when installing new batteries (battery type CR 2032).
- Limited functionality is available without the remote control (see 'Control without remote').

## DISPOSAL INFORMATION

- Dyson products are made from high grade recyclable materials. Recycle where possible.
- The battery should be removed from the product before disposal.
- Dispose of or recycle the battery in accordance with local ordinances or regulations.

## DYSON CUSTOMER CARE

### THANK YOU FOR CHOOSING TO BUY A DYSON APPLIANCE

After registering your free 2 year guarantee, your Dyson appliance will be covered for parts and labour for 2 years from the date of purchase, subject to the terms of the guarantee. If you have any questions about your Dyson appliance, call the Dyson Helpline with your serial number and details of where/when you bought the appliance.

Most questions can be solved over the phone by one of our trained Dyson Helpline staff.

Alternatively, visit [www.dyson.co.uk/support](http://www.dyson.co.uk/support) (UK) or [www.dyson.ie/support](http://www.dyson.ie/support) (ROI) for online help, general tips and useful information about Dyson. Your serial number can be found on your rating plate which is on the base of the appliance.

If your Dyson appliance needs a service, call the Dyson Helpline so we can discuss the available options. If your Dyson appliance is under guarantee, and the repair is covered, it will be repaired at no cost.

## PLEASE REGISTER AS A DYSON APPLIANCE OWNER

To help us ensure you receive prompt and efficient service, please register as a Dyson appliance owner. There are three ways to do this:

- Online at [www.dyson.co.uk/register](http://www.dyson.co.uk/register) (UK) or [www.dyson.ie/register](http://www.dyson.ie/register) (ROI).
- Telephone the Dyson Helpline.
- Complete the enclosed form and post it to us. This will confirm ownership of your Dyson appliance in the event of an insurance loss, and enable us to contact you if necessary.

## LIMITED 2 YEAR GUARANTEE

### TERMS AND CONDITIONS OF THE DYSON 2 YEAR LIMITED GUARANTEE

## WHAT IS COVERED

- The repair or replacement of your Dyson appliance (at Dyson's discretion) if it is found to be defective due to faulty materials, workmanship or function within 2 years of purchase or delivery (if any part is no longer available or out of manufacture Dyson will replace it with a functional replacement part).
- Where this appliance is sold outside of the EU, this guarantee will only be valid if the appliance is used in the country in which it was sold.
- Where this appliance is sold within the EU, this guarantee will only be valid (i) if the appliance is used in the country in which it was sold or (ii), if the appliance is used in Austria, Belgium, France, Germany, Ireland, Italy, Netherlands, Spain or the United Kingdom and the same model as this appliance is sold at the same voltage rating in the relevant country.

## WHAT IS NOT COVERED

Dyson does not guarantee the repair or replacement of a product where a defect is the result of:

- Accidental damage, faults caused by negligent use or care, misuse, neglect, careless operation or handling of the appliance which is not in accordance with the Dyson Operating Manual.
  - Use of the appliance for anything other than normal domestic household purposes.
  - Use of parts not assembled or installed in accordance with the instructions of Dyson.
  - Use of parts and accessories which are not genuine Dyson components.
  - Faulty installation (except where installed by Dyson).
  - Repairs or alterations carried out by parties other than Dyson or its authorised agents.
  - Blockages – please refer to the Dyson Operating Manual for details of how to look for and clear blockages.
  - Normal wear and tear (e.g. fuse etc.).
  - Reduction in battery discharge time due to battery age or use (where applicable).
- If you are in any doubt as to what is covered by your guarantee, please contact Dyson.

## SUMMARY OF COVER

- The guarantee becomes effective at the date of purchase (or the date of delivery if this is later).
- You must provide proof of (both the original and any subsequent) delivery/purchase before any work can be carried out on your Dyson appliance. Without this proof, any work carried out will be chargeable. Keep your receipt or delivery note.
- All work will be carried out by Dyson or its authorised agents.
- Any parts which are replaced by Dyson will become the property of Dyson.
- The repair or replacement of your Dyson appliance under guarantee will not extend the period of guarantee.
- The guarantee provides benefits which are additional to and do not affect your statutory rights as a consumer.

## ABOUT YOUR PRIVACY

- Your information will be held by Dyson and its agents for promotional, marketing and servicing purposes.
- If your personal details change, if you change your mind about any of your marketing preferences or if you have any queries about how we use your information, please contact Dyson.
- For more information on how we protect your privacy, please see our privacy policy on the Dyson website.



## Dyson Customer Care

If you have a question about your Dyson appliance, call the Dyson Customer Care Helpline with your serial number and details of where and when you bought the appliance, or contact us via the Dyson website.

### DYSON CONTACT DETAILS

UK:

Website: [www.dyson.co.uk/support](http://www.dyson.co.uk/support)

Dyson Helpline: 0800 298 0298

Email: [askdyson@dyson.co.uk](mailto:askdyson@dyson.co.uk)

Address: Dyson Ltd, Tetbury Hill, Malmesbury, Wiltshire, SN16 0RP

ROI:

Website: [www.dyson.ie/support](http://www.dyson.ie/support)

Dyson Helpline: 01 475 7109

Email: [askdyson@dyson.co.uk](mailto:askdyson@dyson.co.uk)

Address: Dyson Ireland Limited, Unit G10, Grants Lane, Greenogue Business Park, Rathcoole, Dublin 24

[www.dyson.com](http://www.dyson.com)



Serial number

[Large empty box for serial number]

Date of purchase

[Date selection boxes: / / ]

Country of purchase

[UK] [ROI]

Title

Surname

[Title and Surname input boxes]

First name

[First name input box]

Address

[Address input grid]

Postcode

[Postcode input box]

email

[Email input box]

Telephone

Mobile

[Telephone and Mobile input boxes]

As a Dyson fan owner, you can hear about Dyson inventions, services and products before anyone else. If it's okay to contact you, please let us know how we may do this.

We sometimes ask other companies (such as market researchers) to contact owners on our behalf. We do this to get feedback on ideas or ask you to try new products and services. Would this be okay?

By mail Yes [ ] No [ ]
By phone Yes [ ] No [ ]
By email Yes [ ] No [ ]
By text message Yes [ ] No [ ]

Yes [ ] No [ ]

3 EASY WAYS TO REGISTER YOUR FREE 2 YEAR GUARANTEE

REGISTER ONLINE
Visit our website to register your full parts and labour guarantee online.
www.dyson.co.uk/register
www.dyson.ie/register

REGISTER BY PHONE
Call our dedicated Helpline. Open Monday to Friday 8am-8pm & Saturday and Sunday 8am-6pm.
UK: 0800 298 0298
ROI: 01 475 7109

REGISTER BY MAIL
Complete and return the form to Dyson in the envelope supplied.

