

How to use your robot.

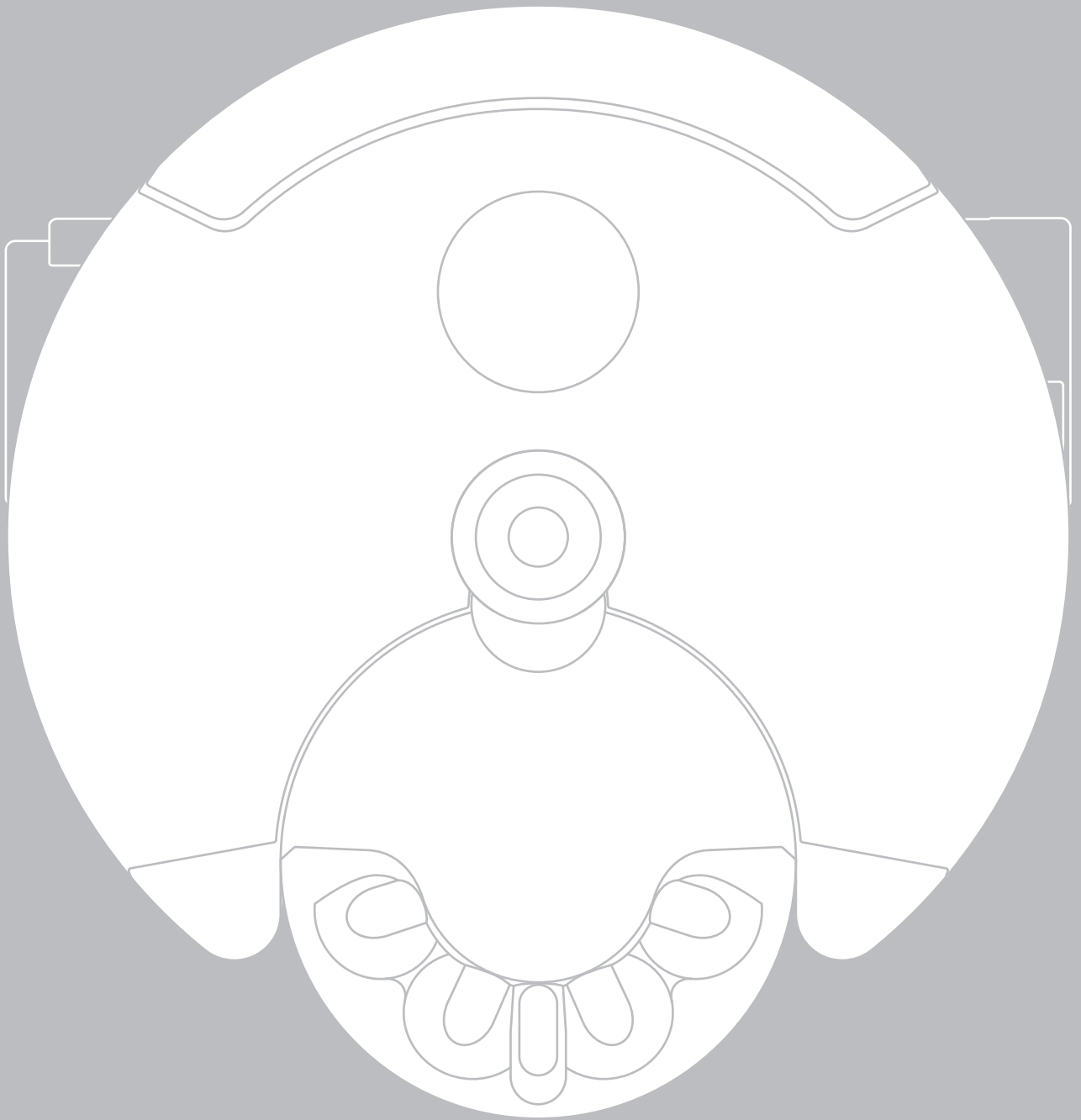

Contents

Getting started

- 4 Important safety instructions
- 8 Quick start
- 10 Dyson Link app
- 11 Getting connected: Part 1
- 12 Getting connected: Part 2 iOS
- 14 Getting connected: Part 2 Android
- 16 Cleaning modes
- 18 Understanding and optimising your robot.

Maintenance

- 20 Emptying the clear bin
- 21 Brush bar and track maintenance
- 22 Washing and drying the filters
- 24 Cleaning optics
- 25 Software updates

Important information

- 26 Troubleshooting
- 28 Additional information

Thank you for choosing to buy the Dyson 360 Eye™ robot.

We're here to help:



Online

Support site:
www.dyson.co.uk/support/robots

Robot owner's site:
www.dyson.co.uk/robot-owners

Ask Dyson:
www.youtube.com/AskDyson

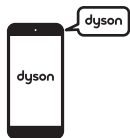

Support Centre

Call: 0800 298 0298 between Monday to Friday 8am-8pm & Saturday and Sunday 8am-6pm

Email: ukhelpline@dyson.co.uk

Chat: www.dyson.co.uk/support/robots



Download the Dyson Link app

The Dyson Link app allows you to control, monitor and get automatic updates for the Dyson 360 Eye™ robot via your mobile device.

Search for the latest Dyson Link app on the App store or Google Play.

In the box

Robot

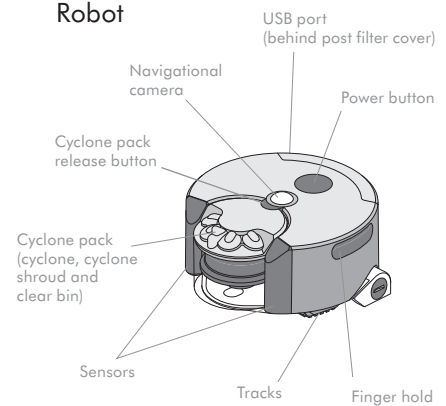

Dock

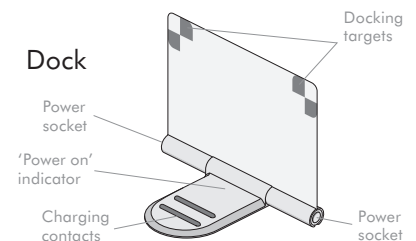

Plug

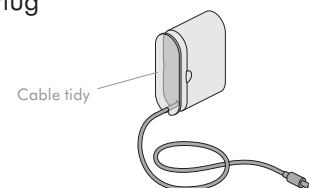



IMPORTANT SAFETY INSTRUCTIONS

BEFORE USING THIS APPLIANCE READ ALL INSTRUCTIONS AND CAUTIONARY MARKINGS IN THIS MANUAL AND ON THE APPLIANCE

When using an electrical appliance, basic precautions should always be followed, including the following:

WARNING

These warnings apply to the appliance, charging dock and charger.

TO REDUCE THE RISK OF FIRE, ELECTRIC SHOCK, OR INJURY:

1. This Dyson appliance can be used by children aged from 8 years and above and persons with reduced physical, sensory or reasoning capabilities, or lack of experience and knowledge, only if they have been given supervision or instruction by a responsible person concerning use of the appliance in a safe way and understand the hazards involved. Cleaning and user maintenance shall not be made by children without supervision.
2. Do not allow to be used as a toy. Close attention is necessary when used by, or near, children and pets. Children should be supervised to ensure that they do not play with the appliance. Do not allow children or pets to sit on the appliance.
3. Use only as described in this Dyson Operating Manual. Do not carry out any maintenance other than that shown in this manual, on the Dyson Link app, on the Dyson website, or as advised by the Dyson Helpline.
4. If the appliance is not working as it should, has received a sharp blow, has been dropped, damaged, left outdoors, or dropped into water, do not use and contact the Dyson Helpline.
5. If there is a problem with your Dyson appliance, refer to the diagnostic information in this manual, on the Dyson website, and on the Dyson Link app. If service or repair is needed, contact the Dyson Helpline so we can discuss the available options. Do not disassemble the appliance as incorrect reassembly may result in an electric shock or fire.
6. Suitable for dry locations **ONLY**. Do not use outdoors or on wet surfaces or where contact with, or immersion in, water is a possibility.

7. Do not install, charge or use this appliance outdoors, in a bathroom or within 3 metres (10 feet) of a pool. Do not use on wet surfaces and do not expose to moisture, rain or snow.
8. Do not operate the appliance where it can pick up any water.
9. Do not spill water on the appliance.
10. Do not handle any part of the charger, charging dock or appliance with wet hands.
11. Do not use with a damaged cable or plug. If the supply cable is damaged it must be replaced by Dyson, its service agent or similarly qualified person in order to avoid a hazard.
12. Make sure the cable is located so that it will not be stepped on, tripped over, run over by the appliance or otherwise subjected to damage or stress.
13. Do not unplug the charger by pulling on the cable. To unplug, grasp the charger, not the cable. The use of an extension cable is not recommended.
14. Unplug the charging dock when not in use for extended periods and before maintenance or servicing.
15. Do not operate the appliance where it can pick up flammable or combustible liquids, such as petrol, or use in areas where they or their vapours may be present.
16. Do not operate the appliance where it can pick up anything that is burning or smoking, such as cigarettes, matches, or hot ashes.
17. Do not operate the appliance in an area where there are open fireplaces, lit candles or fragile objects on the floor to be cleaned or where there are candles on candlesticks, tables, etc. that the appliance may accidentally hit or bump into.
18. Remove all electrical cables and other items that could get tangled in the appliance from the area to be cleaned before use.
19. Ensure that everyone in the household is aware of the machine when it is in use, particularly when using the scheduled clean function available via the Dyson Link app.
20. Do not operate the appliance in a room where an infant or child is present and unattended.
21. Risk of falling: Do not use the appliance in any area where it can access a down stairway or balcony, etc. Do not use in high or narrow spaces such as a shelf or stairs.
22. Keep hair, loose clothing, fingers, and all parts of the body away from openings and moving parts such as the tracks and the brush bar.
23. Do not put any object into openings. Do not use with any opening blocked; keep free of dust, lint, hair, and anything that may reduce airflow.
24. Do not touch the charging points on the appliance or the charging dock with any object.
25. Do not use without the clear bin and filters in place.
26. Do not obscure the sensors or vision system.
27. Do not put anything on top of the appliance.
28. Carry the appliance only by the finger holds on each side.

29. The appliance and charging dock must be supplied at their rated Safety Extra Low Voltage, use only the Dyson power adaptor and battery supplied with the product, other types of batteries may burst causing injury to persons and damage.
30. Use only Dyson recommended accessories and replacement parts.
31. FIRE WARNING – Do not place this product on or near a cooker or any other hot surface and do not incinerate this appliance even if it is severely damaged. The battery might catch fire or explode.
32. FIRE WARNING – Do not apply any fragrance or scented product to the filter(s) of this appliance. The chemicals in such products are known to be flammable and can cause the appliance to catch fire.

READ AND SAVE THESE INSTRUCTIONS

**THIS DYSON APPLIANCE IS INTENDED
FOR HOUSEHOLD USE ONLY**

Quick start

1

Setting Up

Open the dock fully to 90° and place it against the wall. Plug the charging lead into either side of the dock. Ensure the dock is powered, indicated by a blue light on the dock. Tidy any surplus cable by wrapping it around the plug. Ensure no objects are within approximately a 50cm radius of the dock.

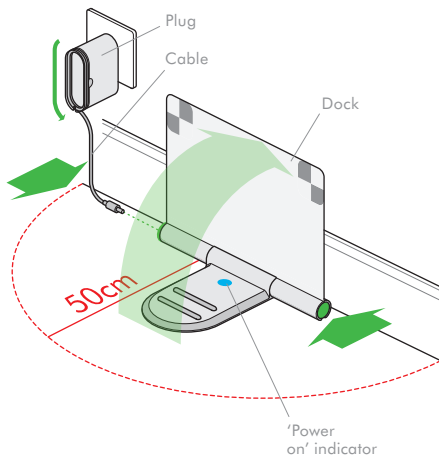

2

Charging

Place the robot on the dock with the clear bin facing the wall. The battery light, located on the power button, will pulsate, turning solid when fully charged.

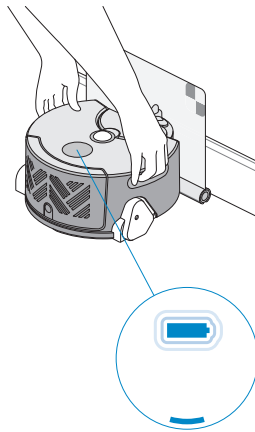

3

Preparing the room

Your robot cleans using powerful suction, please:

- Remove thin rugs or loose items that may be sucked up, limiting movement.
- Tidy obstacles such as shoe laces or thin cables that may become entangled in the brush bar.
- Clean any liquid spills or sharp items that may cause damage to the robot.

Your robot uses infra-red sensors to detect drops, please:

- Ensure there is no clutter such as bags or shoes within 10cm of any drops in the room.

Your robot uses a camera to navigate, please:

- Provide adequate illumination for the robot to navigate throughout the clean.



Go to
www.dyson.co.uk/support/robots

4

Cleaning

Press the power button. The robot will begin cleaning all accessible space, recharging at its dock when required.

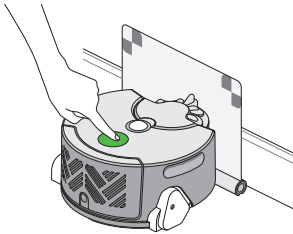

5



Get the Dyson Link App

To schedule cleans, view maps of previous cleaning sessions, diagnose faults and automatically update software on your robot, please download the Dyson Link app for free on the App Store or Google Play.

See the 'setting up Dyson Link app' page in this user guide for setup instructions.

6

Update your robot

To ensure you get the best out of your robot update to the latest software.

To register for automatic updates connect your robot using the Dyson Link app.

To update without using the app, download the latest software from: www.dyson.com/support/robots



Dyson Link app

The Dyson Link app allows you to control, schedule and monitor your Dyson 360 Eye™ robot even when you're not at home.

Functionality

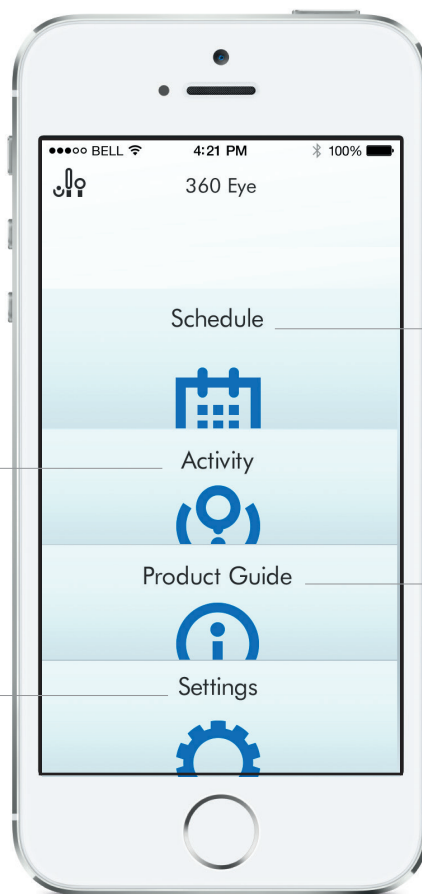

Review data from your robot's last five completed cleans, including a cleaning map of the areas covered in your home.

Give your robot a name, control notifications, configure settings and check your robot's software version.

Choose when your robot cleans by scheduling the time and day of cleaning sessions.

Explore key technologies inside Dyson 360 Eye™ robot, and access troubleshooting support.

*Featured content based on version 1 of the app. Visit our website for further assistance:

www.dyson.co.uk/support/robots

Getting connected: Part 1

Before you begin

1

Download the app

Search for the latest Dyson Link app on the App Store or Google Play.



2

Ensure you have the following information:

Home Wi-Fi password

Robot's serial number

Make a note of the robot's serial number – you will need this to identify your robot's Wi-Fi network during connection. This can be found either on the back of this user guide or behind the clear bin on the robot.

Robot's code

Make a note of the robot's code - you will need this to connect your robot. This can be found either on the back of this user guide or behind the clear bin on the robot.

3

Check your Wi-Fi

Check that your dock is set up only a short distance from your Wi-Fi router and that it is powered.

Make sure that your device is on the same network that you want to connect your robot to.

The robot connects to 2.4GHz networks, which includes most modern routers.

Check your router documentation for compatibility.

Supported Wi-Fi protocols

- IEEE802.11b (Not recommended)
- IEEE802.11g
- IEEE802.11n (Support only for 2.4GHz)

Check that your device's Wi-Fi is enabled and that it has a strong Wi-Fi signal, for example try visiting your favourite web site.

Further information is available at www.dyson.co.uk/support/robots

If you require any assistance please contact the Dyson Helpline on 0800 298 0298

Getting connected: Part 2 iOS

Connect robot to your iOS device and home Wi-Fi.

1



Register your account

Launch the app on your mobile device.

Select your country.

If you already have a Dyson account select 'Sign in' and enter your username and password.

If you are new, select 'Register'.

To create an account, complete all fields.

2



Confirm your home Wi-Fi network

The app will recommend a Wi-Fi network to connect the robot to.

This will be the network your mobile device is already connected to.

If this is the Wi-Fi network you would like to connect your robot to, enter your Wi-Fi password.

3

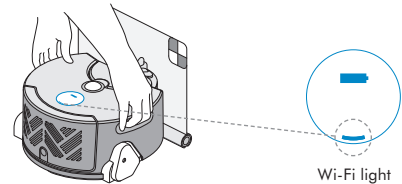

Make your robot discoverable

Pick up and replace the robot on a powered dock. After a short while the Wi-Fi light will illuminate, the robot is now discoverable.

Need a little help?

Not sure you have an account?

This is the account you set-up to purchase your robot on dyson.co.uk

Can't download the app on to your mobile device?

The Dyson Link app is currently only available to iOS and Android phones. We will keep adding devices, so please check the app store in the country you bought your robot in.

Can't see your home network?

- Check that you are setting up close to your home Wi-Fi router.
- Check that your home router is switched on.
- Check that your mobile device is connected to Wi-Fi, indicated by a Wi-Fi signal icon in the top left corner of the screen.
- Check that your home network is not hidden.

Want to connect your robot to a different network?

Leave the Dyson Link app, open the settings app on your mobile device and choose Wi-Fi. Connect to your preferred network and return to the Dyson Link app. Check that you aren't connected to a 5GHz network. Your robot will only connect to a 2.4GHz network.

Can't see the Wi-Fi light?

- The robot will remain discoverable for 30 minutes after being placed on the powered dock.
- Check that the dock is powered – a blue power light will be showing on the dock.
- Pick up and replace the robot on the dock.
- Check that your robot is charging, indicated by the battery light on the robot.

4

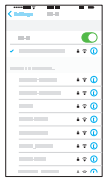

Connect your mobile device to your robot's Wi-Fi network

Leave the app, go to your mobile device settings and select Wi-Fi:

Choose your 360 Eye network (this will contain '360EYE' and the robot's serial number).

When prompted, enter the robot's code. This can be found either on the back of the user guide or behind your robot's clear bin.

Now, return to the Dyson Link app.

5

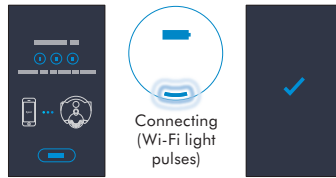

Connect your robot to your home Wi-Fi network and to Dyson

The Wi-Fi light on your robot will pulse while connecting.

When connected the light will turn off; if the robot fails to connect the light will become solid again.

6

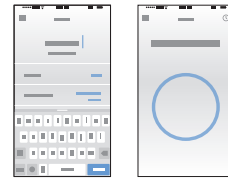

Name your robot and get started!

Once you have registered your ownership and named your robot you can get started.

Can't see your robot in the list of available networks?

- Check that your robot's Wi-Fi light is illuminated, see step 3 in this guide.
- Check that your mobile device's Wi-Fi is enabled and that you are only a short distance from your robot.
- Your robot's Wi-Fi starts with '360EYE'.

Can't connect your app to your robot?

- Make sure that you are only a short distance from your robot.
- To reconnect your phone to your robot, repeat step 4 in this guide.

Can't connect your robot to your Wi-Fi?

- Your Wi-Fi might not be responding.
- If you've hidden your Wi-Fi, unhide it.
- Check that you haven't set your Wi-Fi to 5GHz. Your Wi-Fi needs to be set to 2.4GHz.

Can't connect your robot to the Dyson network?

- The Dyson cloud might not have been able to complete your connection, please try again.

*Featured content based on version 1 of the app. Visit our website for further assistance:

www.dyson.co.uk/support/robots

Getting connected: Part 2 Android

Connect robot to your Android device and home Wi-Fi.

1



Register your account

Launch the app on your mobile device.

Select your country.

If you already have a Dyson account select 'Sign in' and enter your username and password.

If you are new, select 'Register'.

To create an account, complete all fields.

2

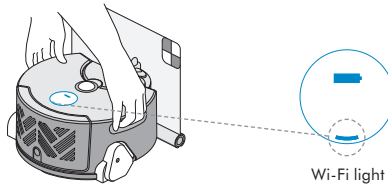

Make your robot discoverable

Pick up and replace the robot on a powered dock. After a short while the Wi-Fi light will illuminate, the robot is now discoverable.

3



Confirm your home Wi-Fi network

The app will recommend a Wi-Fi network to connect the robot to.

This will be the network your mobile device is already connected to.

If this is the Wi-Fi network you would like to connect your robot to, enter your Wi-Fi password.

Need a little help?

Not sure you have an account?

This is the account you set-up to purchase your robot on dyson.co.uk

Can't download the app on to your mobile device?

The Dyson Link app is currently only available to iOS and Android phones. We will keep adding devices, so please check the app store in the country you bought your robot in.

Can't see the Wi-Fi light?

- The robot will remain discoverable for 30 minutes after being placed on the powered dock.
- Check that the dock is powered – a blue power light will be showing on the dock.
- Pick up and replace the robot on the dock.
- Check that your robot is charging, indicated by the battery light on the robot.

Can't see your home network?

- Check that you are setting up close to your home Wi-Fi router.
- Check that your home router is switched on.
- Check that your mobile device is connected to Wi-Fi, indicated by a Wi-Fi signal icon in the top left corner of the screen.
- Check that your home network is not hidden.

Want to connect your robot to a different network?

- You can select a different network from within the app.

4



Connect your mobile device to your robot's Wi-Fi network

When prompted, enter the robot's code. This can be found either on the back of the user guide or behind your robot's clear bin.

5



Connecting
(Wi-Fi light
pulses)



Connect your robot to your home Wi-Fi network and to Dyson

The Wi-Fi light on your robot will pulse while connecting.

When connected the light will turn off; if the robot fails to connect the light will become solid again.

6



Name your robot and get started!

Once you have registered your ownership and named your robot you can get started.

Can't see your robot?

Check that your robot's Wi-Fi light is illuminated, see step 2 in this guide.
Check that your mobile device's Wi-Fi is enabled and that you are only a short distance from your robot.

Can't connect your app to your robot?

- Make sure that you are only a short distance from your robot.
- Check that the robot's Wi-Fi light is illuminated.

Can't connect your robot to your Wi-Fi?

- Your Wi-Fi might not be responding.
- If you've hidden your Wi-Fi, unhide it.
- Check that you haven't set your Wi-Fi to 5GHz.
- Your Wi-Fi needs to be set to 2.4GHz.

Can't connect your robot to the Dyson network?

The Dyson cloud might not have been able to complete your connection, please try again.

*Featured content based on version 1 of the app. Visit our website for further assistance:

www.dyson.co.uk/support/robots

Cleaning modes

Automatic recharging mode
Robot cleans all accessible space,
recharging at its dock when required.

1

Place the robot on the dock.
Ensure the dock is powered
and the robot is charging.

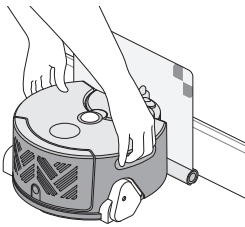

2

Press the power button
and the robot will begin
cleaning all accessible space.

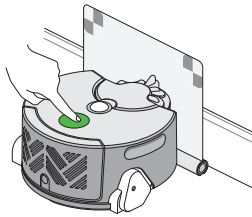

3

The robot will return to the dock
to recharge when the battery is low.

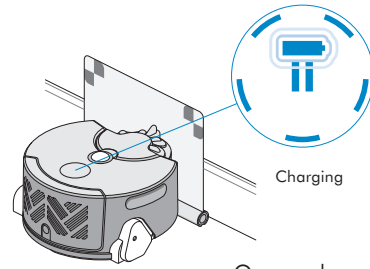

Once recharged,
the robot will
automatically
continue with the
cleaning session.

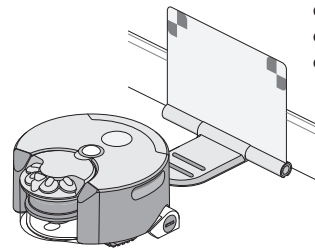

Lights

On/off/pause

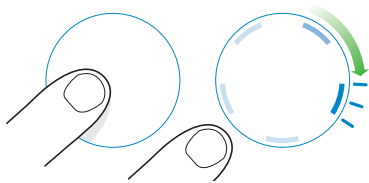

To switch 'ON', press the power button
until the blue lights come on.

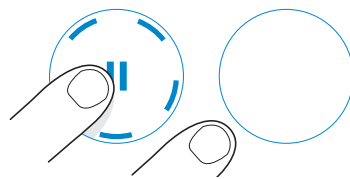

To switch 'OFF', press the power button
until the lights go out.

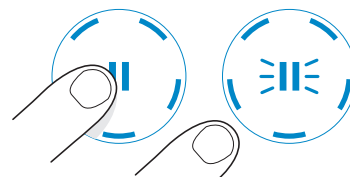

To pause, press the power button.
The pause light will flash.
Press again to continue cleaning.

Single charge mode: Robot cleans the accessible space it can reach on a single charge only.

1

Place the robot on the floor, not on the dock.

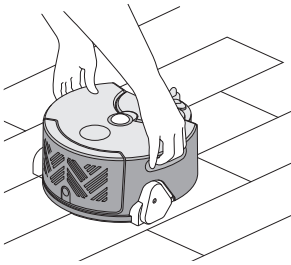

2

Press the power button and the robot will begin cleaning the accessible space it can reach on a single charge only.

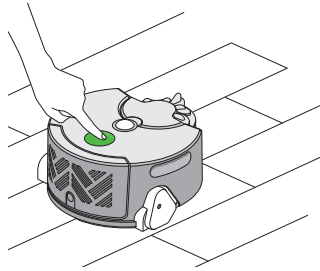

3

The robot will not recharge when the battery is low, but return to its starting point and switch 'OFF'.

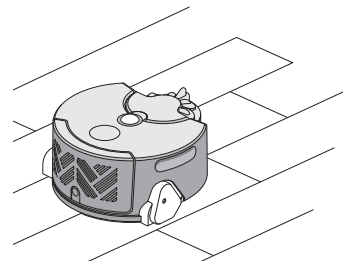

Standby

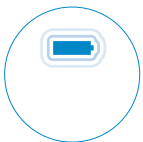

Charging.

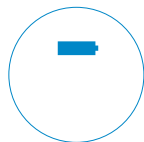

Charged.

Cleaning



Performing
a clean.



Heading back
to charge.



Charging (during
a clean).

Understanding and optimising your robot.

Suction

Your robot uses a Dyson digital motor and full width brushbar to deliver powerful cleaning.

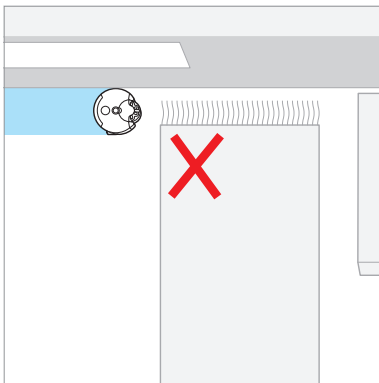

Tidy thin, lightweight or loose items that may be sucked up and impair movement.

Should a blockage occur, the robot will attempt to clear the blockage by reducing suction for a short period.

If the robot becomes stuck on an obstacle: clear the obstacle, replace the robot as close as possible to where you picked it up (ideally somewhere the robot has already cleaned) and press the pause button to continue cleaning.

Navigation

Your robot uses a 360° vision system to take a full panoramic image of the room.

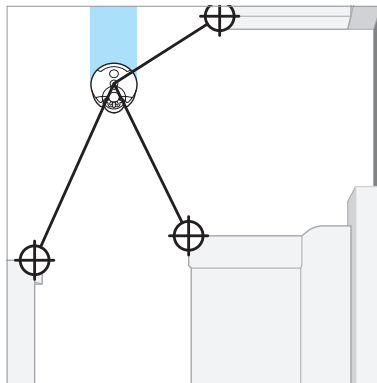

The robot navigates by identifying features in its field of view and tracking these as it moves.

To improve the robot's ability to navigate, please provide adequate and consistent illumination throughout the duration of the clean.

In low light the robot will supplement ambient illumination with infra-red headlights.

To maintain navigation performance clean the camera and headlights regularly. See the 'Cleaning Optics' section in this manual.

For safety reasons the drop sensors are very sensitive. Your robot may mistake dark surfaces as drops and consequently will not clean over them.

Cleaning behaviour

Your robot maps out your home into a grid of squares, and cleans it using a systematic cleaning pattern.

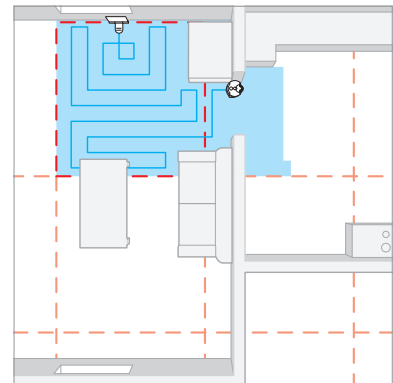

The grid does not always line up with the edges of the room, the robot may clean into another room before returning to clean areas it has missed.

If your robot had trouble navigating into an area, or if it is taking a long time to clean, next time try moving the dock. This will realign the boundaries of the grid to you home and may improve performance.

To visualise the robot's cleaning behaviour and see maps of completed cleans, connect your robot using the Dyson Link app.

Your robot uses infra-red sensors to identify obstacles, drops and the boundaries of the cleaning space. It then records these on its map.

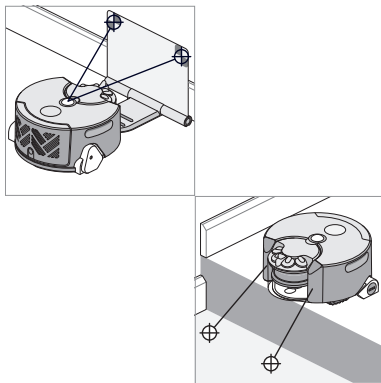

If you do not want the robot to access an area, provide a physical barrier, such as closing a door.

Remove all clutter within 10cm of drops as this may interfere with the drop sensors.

The robot will occasionally detect some obstacles by nudging them: please tidy any fragile items from the floor space.

When started from the dock your robot will return to recharge mid-clean before automatically resuming and completing the clean.

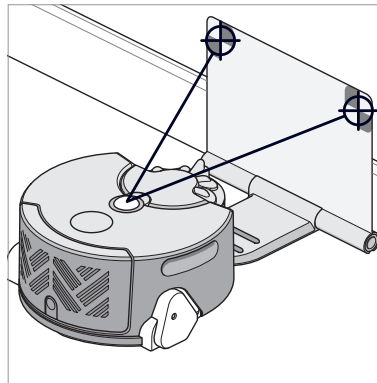

Your robot identifies the dock location using the 360° camera: please make sure that the dock is well lit and is placed in an open, uncluttered area.

Your robot aligns its map to its start orientation on the dock: place the dock on a firm, level surface, flat against a wall.

If your robot has trouble getting back to the dock, try moving the dock's location before the next clean.

Your robot is powered using a lithium-ion battery pack.

Charge time: 2hrs 45mins

Run time: 45mins

Your robot's charge and run times are approximate, as they depend on many factors including charge remaining in the battery, operating temperature and the age of the battery.

Run time will also be influenced by the layout of your home and type of floor surface being cleaned.

To optimise the time it spends cleaning, your robot's charge time will be less when recharging at its dock mid-clean.

You do not have to wait for the robot's battery to be fully charged before starting a clean, however if you request a clean when the robot's battery is too low it will display a 'Return to the dock' light.

Emptying the clear bin

To empty the bin during a clean press the power button to pause the robot. Once you've finished, return the robot to the same point on the floor, press the power button again to resume cleaning.

1

When dirt reaches the MAX mark it's time to empty the clear bin.

Make sure that the clear bin is emptied before each use.

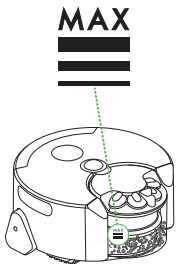

2

Press the cyclone pack release button.

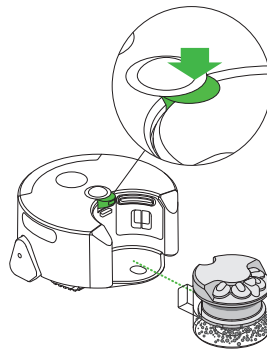

3

Lift the cyclone out of the clear bin.

Empty the contents into a bin. To minimise dust/allergen contact when emptying, encase the clear bin tightly in a plastic bag and empty.

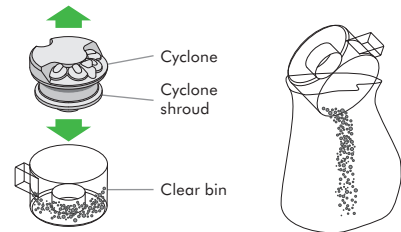

Cleaning the clear bin

Clean the clear bin with cold water only.

Clean the cyclone shroud with a cloth or dry brush to remove any lint and dust.

Ensure the clear bin is completely dry before replacing.

Do not immerse the whole cyclone in water or pour water into the cyclones.

Brush bar and track maintenance

To conduct brush bar or track maintenance during cleaning press the power button to pause the robot. When you are ready, return the robot to the same point on the floor, press the power button again to resume cleaning.

1

Using a coin, turn the brush bar fastener anti-clockwise.

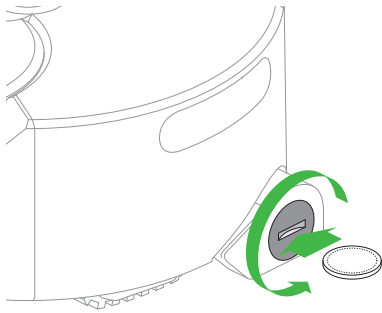

2

Remove the brush bar.
Remove any debris by hand.
Replace the brush bar.
Turn clockwise to lock.

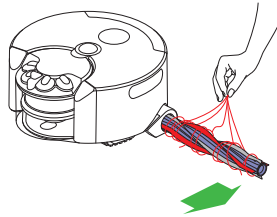

3

Carefully place the robot upside down on a soft surface. Remove any debris by hand.

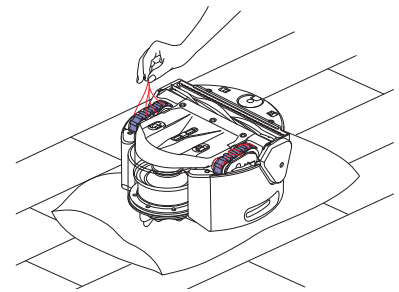

Washing and drying the filters

Pre-motor filter

Wash the pre-motor filter at least every month according to the instructions below to maintain performance.

1

Press the cyclone release button and remove the cyclone unit.

Pull out the pre filter.

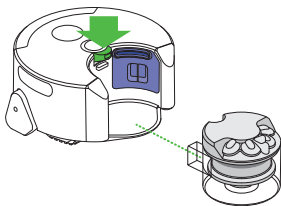

2

Wash the filter with cold water only. No hot water and no detergents.

Shake the filter to remove debris and excess water.

Repeat the wash/shake cycle until the water runs clear.

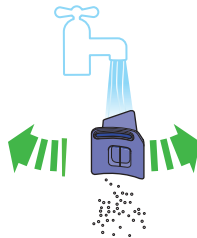

3

Allow to completely dry naturally (24 hours minimum).

To refit, re-assemble in reverse order.

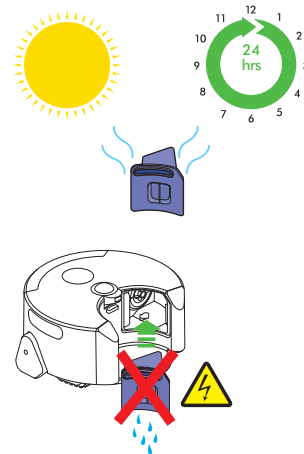

Post-motor filter

Wash the post-motor filter at least every month according to the instructions below to maintain performance.

1

Press in the filter release button and slide the filter cover up. Remove the filter.

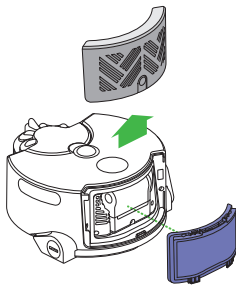

2

Wash the filter with cold water only. No hot water and no detergents.

Shake the filter to remove debris and excess water.

Repeat the wash/shake cycle until the water runs clear.



3

Allow to completely dry naturally (24 hours minimum).

To refit: align the tabs on the bottom of the filter with the slots on the robot, then push the top of the filter into place. Slide the filter cover downwards.

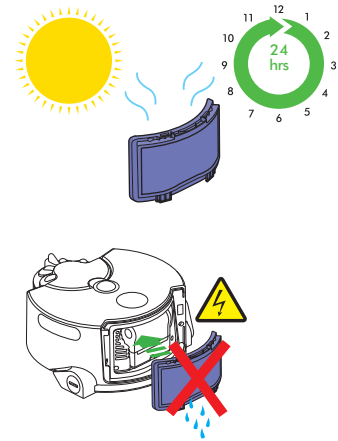

Cleaning optics

To get the best navigational performance from your robot, clean the optics frequently.

Check all sensor covers and the navigational camera for dirt, fingerprints or smears. Wipe with a soft, dry, microfibre cloth to clean. Do not use cleaning fluids, liquids or sprays of any kind.

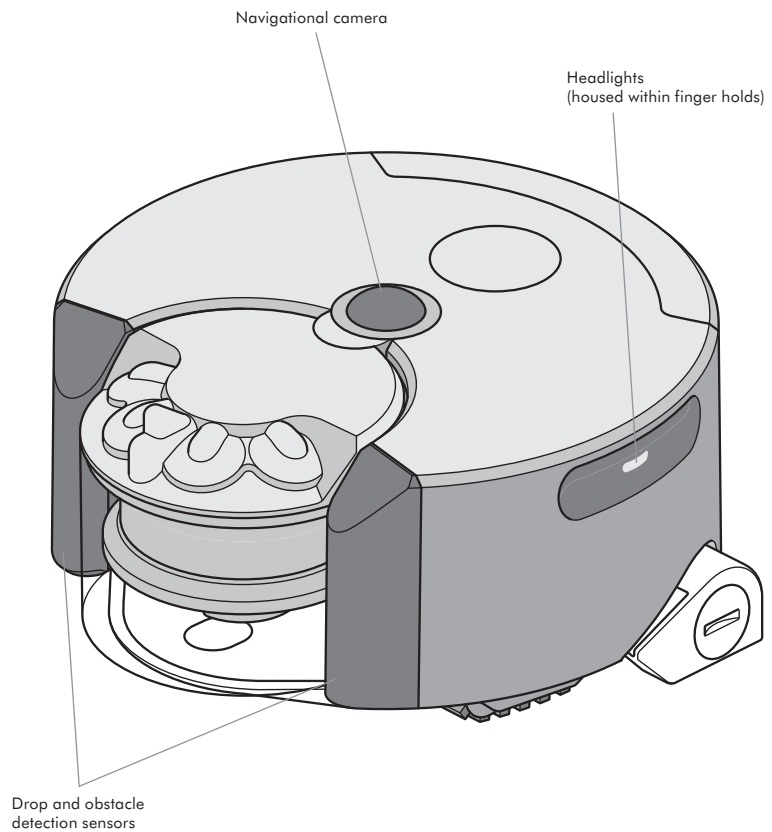

Software updates

Go to
www.dyson.co.uk/support/robots

To ensure you get the best out of your robot update to the latest software.



Automatic updates via the Dyson Link app

1

By downloading the Dyson Link app you will be registered for automatic updates.

2

When an update becomes available for your robot it will automatically download and install at the next available opportunity (when the robot is inactive, on the dock and connected to Wi-Fi).

3

Update progress will be indicated by a sequence of pink lights. Do not attempt to interrupt the update sequence until it has completed. Removal of the battery during an update may cause irreparable damage.

Once complete the lights will turn off. The robot is ready to use again.

Manually update via USB

1

Check for a software update on the Dyson website.

Download the update file onto a USB stick without naming it. The USB stick must have at least 256MB of free space and must have no other files or folders on it.

Remove the post-filter from the robot and insert the stick into the USB port on the back of the machine.

2

Press and hold the power button until a ring of pink lights flash to indicate that the robot has started the update.

3

Update progress will be indicated by a sequence of pink lights. Do not attempt to interrupt the update sequence until it has completed. Removal of the battery during an update may cause irreparable damage.

Once complete the lights will turn off. The robot is ready to use again.



Troubleshooting

1

If your robot encounters a problem, it will display one of the lighting patterns below. Follow the instructions to fix the issue.

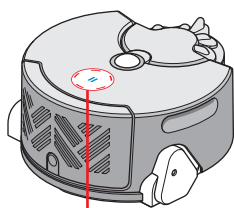

2

When the problem has been fixed, return the robot to the same point on the floor, press the power button again and step away to resume cleaning.

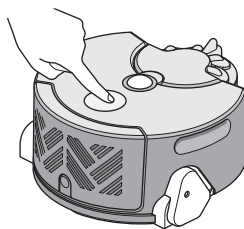

Airways

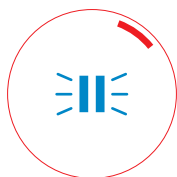

Check that a seal has not formed between the brush bar and the cleaning surface.

Check that the clear bin is fitted correctly.

If the clear bin is full, empty it.

Check that the cyclone shroud isn't covered or blocked.

Remove the cyclone pack and check the airways behind it for blockages.

Remove the brush bar and check the airways for blockages.

Check for blockages on both filters.

Wash both filters.

Check the filters are in place.

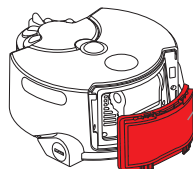
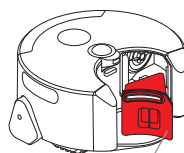
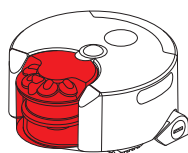

Post-motor filter



Brush bar

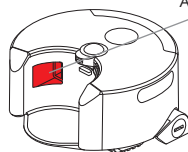

Airways

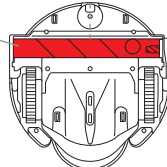

Pre-motor filter

Brush bar/tracks

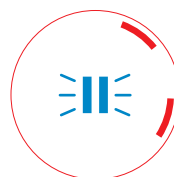

If your robot becomes stuck, please move the robot off the obstruction and place nearby to resume cleaning.

Check the brush bar for wrapped hair or debris and remove.

Check that the brush bar is correctly fitted.

Check the tracks and remove any wrapped hair and debris.

For further information please refer to the 'Brush bar and track maintenance' section



Brush bar

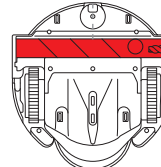

Tracks

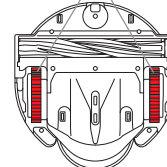

For more support



Online
www.dyson.co.uk/support/robots



On the phone:
Call our helpline for dedicated support on 0800 298 0298 between Monday to Friday 8am-8pm & Saturday and Sunday 8am-6pm



On the Dyson link app:
You can use the Dyson Link app to identify problems, view video guides and take you through simple step-by-step diagnostics to resolve.

Software updates

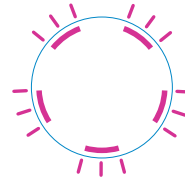

Pink lights indicate a software upgrade is in progress.

Dock



Check that power is going to the dock: the 'Power on' indicator panel should illuminate on the base of the dock.

Check that the charging contacts on the robot and the dock are clean and not obstructed.

Check that the docking targets are folded out correctly. Targets should be parallel to the wall and facing out to the room.

Check the dock hasn't been moved since the robot started cleaning, as this may interrupt the mapping sequence.

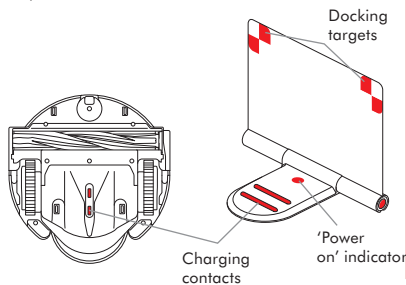

Optics

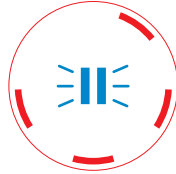

Check all sensor covers and the navigational camera for dirt, fingerprints or smears. Wipe with a soft, dry, microfibre cloth to clean. Do not use cleaning fluids, liquids or sprays of any kind.

Check that there is adequate lighting for the robot to operate across all cleaning areas, including those already cleaned.

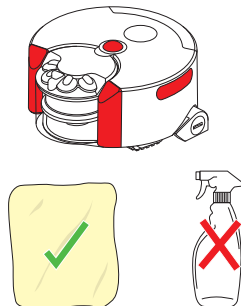

Contact the Dyson Helpline

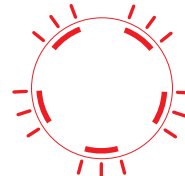

5 red flashing lights indicates that your robot has encountered a fault that you cannot fix. Please contact the Dyson helpline.

Return to the dock

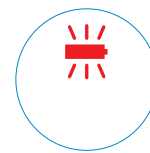

Red battery light flashing indicates that your robot cannot complete the clean. Please return your robot to the dock.

Additional information

PLEASE READ THE 'IMPORTANT SAFETY INSTRUCTIONS' IN THIS DYSON OPERATING MANUAL BEFORE PROCEEDING.

PREPARING TO CLEAN

- To ensure the best performance from your robot, it is important to prepare the cleaning surface, removing obstacles such as:
 - Objects that might become entangled in moving parts: Thin cables, such as headphone or charger cables; shoe laces; items of clothing, curtains or fabric; loose ends of rugs such as tassels.
 - Hard to vacuum surfaces: thin, loose rugs such as bath mats or animal hides; very deep pile rugs.
 - Objects that might cause damage or blockage if sucked up: magazines and papers; liquid spills; sharp items.
 - Objects that obscure drops: bags or shoes near a drop.
 - Objects within 10cm of steps.
- To avoid damage to possessions, please remove any fragile items such as vases on pedestals from the cleaning surface.
- Ensure children and pets are kept away from the cleaning area.
- Tell people in the household when the robot is operating.
- The robot's navigation system is not designed to operate in complete darkness, please ensure adequate lighting across all cleaning areas, including those already cleaned. For example, leave the lights on if cleaning at night.

LOOKING AFTER YOUR DYSON APPLIANCE

- Store the robot indoors. Do not use or store it below 3°C (37.4°F). Ensure the robot is at room temperature before operating.
- Clean the robot only with a dry cloth. Do not use any lubricants, cleaning agents, polishes or air fresheners on any part of the robot.

Check all sensor covers and the navigational camera for dirt, fingerprints or smears. Wipe with a soft, dry, microfibre cloth to clean. Do not use cleaning fluids, liquids or sprays of any kind.

- Check the brush bar and tracks regularly and clear away any debris (such as hair). Debris left on the brush bar and tracks may cause damage to flooring when vacuuming.
- Place the robot on a soft surface if it has to be turned over when looking for blockages, etc. This will help to avoid damaging the camera and sensors.

VACUUMING

- Before vacuuming your flooring, rugs and carpets, check the manufacturer's recommended cleaning instructions.
- Before vacuuming highly polished floors, such as wood or lino, first check that the brush bar is free from foreign objects that could cause marking.

- Fine dirt such as flour should only be vacuumed in very small amounts.
- Do not use the robot to pick up sharp hard objects, small toys, pins, paper clips, etc. They may damage the robot.

EMPTYING THE CLEAR BIN

- Make sure that the clear bin is emptied before each use.
- Empty as soon as the dirt reaches the level of the MAX mark – do not overfill.

CLEANING THE CLEAR BIN

- Clean the clear bin with cold water only.
- Clean the cyclone shroud with a cloth or dry brush to remove any lint and dust.
- Ensure the clear bin is completely dry before replacing.
- Do not immerse the cyclones in water or pour water into the cyclones.

WASHING YOUR FILTERS

- Please refer to the 'Washing and drying the filters' section; check and wash the filters regularly according to the instructions to maintain performance.
- The filters may require more frequent washing if vacuuming fine dust.

LOOKING FOR BLOCKAGES

- Ensure the robot is off the dock before looking for blockages. Do not operate as this could result in personal injury.
- Beware of sharp objects when checking for blockages.
- Refit all parts securely before using.
- Clearing blockages is not covered by your guarantee.
- This robot has carbon fibre brushes. Take care if coming into contact with them, as they may cause minor skin irritation. Wash your hands after handling the brushes.

SOFTWARE UPGRADES

- To ensure the best performance from your robot please ensure that the robot's software is regularly upgraded. You can do this either by registering for automatic upgrades via the Dyson Link app or by manually downloading an upgrade via your computer. See 'Software updates' section.

DISABLE WI-FI

- Your robot is automatically set to periodically send out a wi-fi signal that can be picked up as a local network (also called 'AP' mode.) If desired this mode can be switched 'OFF' by following the instructions below.
- Download the 'Disable wi-fi' software from the Dyson website on to a USB stick. Make sure this software is the

only item on the USB stick and the stick has at least 256MB of free space.

- Remove the post-motor filter and filter cover and insert the USB stick into the USB port. Manually replace the robot on a powered dock and ensure it is charging.
- Press the power button until a ring of pink lights flash, then release the button. The software will automatically switch 'OFF' wi-fi mode.
- Once complete the robot will turn off.
- Remove the USB and replace the filter and filter cover. The robot is now ready to use as normal.

ENABLE WI-FI

- If you want to enable the robot to emit a wi-fi signal again, follow the same steps as above but instead download the 'Enable wi-fi mode' software from the Dyson website.

RESETTING THE ROBOT

- If ownership of the robot changes, you may wish to reset the robot so that home network names and passwords are cleared.
- To reset the robot, follow the same steps as the 'disable wi-fi' section but instead download the 'reset robot' software from the Dyson website.

BATTERY SAFETY INSTRUCTIONS

- If the battery needs replacing please contact the Dyson Helpline.
- The battery is a sealed unit and under normal circumstances poses no safety concerns. In the unlikely event that liquid leaks from the battery do not touch the liquid and observe the following precautions:
- Skin contact – can cause irritation. Wash with soap and water.
- Inhalation – can cause respiratory irritation. Expose to fresh air and seek medical advice.
- Eye contact – can cause irritation. Immediately flush eyes thoroughly with water for at least 15 minutes. Seek medical attention.
- Disposal – wear gloves to handle the battery and dispose of immediately, following local ordinances or regulations.

CAUTION

- The battery used in this appliance may present a risk of fire or chemical burn if mistreated. Do not disassemble, short contacts, heat above 60°C (140°F), or incinerate. Replace battery with a Dyson battery only: use of any other battery may present a risk of fire or explosion. Dispose of used battery promptly. Keep away from children. Do not disassemble and do not dispose of in fire.

DISPOSAL INFORMATION

- Dyson products are made from high grade recyclable materials. Recycle where possible.
- The battery should be removed from the product before disposal.
- Dispose of or recycle the battery in accordance with local ordinances or regulations.

GUARANTEE TERMS & CONDITIONS

If you have a question about your Dyson appliance, call the Dyson Customer Care Helpline with your serial number and details of where and when you bought the appliance, or contact us via the website. Most questions can be solved over the phone by one of our Dyson Customer Care Experts.

- During any repairs, Dyson may re-use existing parts that meet our quality standards.
- If the appliance, power supply, plug or charger and charging dock (charger and charging dock where applicable and they are included depending on the model) is faulty, the Dyson Service Centre will repair it. Dyson cannot take responsibility for any damage caused by repairs made in any unauthorized repair center.

PLEASE REGISTER AS A DYSON APPLIANCE OWNER

THANK YOU FOR CHOOSING TO BUY A DYSON APPLIANCE

The warranty for this product is 2 years from the the date of purchase. Please register your guarantee within 30 days of your purchase date. To help us ensure you receive prompt and efficient service, please register immediately after purchase. Please keep the receipt showing the date of purchase. Please register the guarantee using one of the following methods.

- Register using the Dyson Link app.
- Online at www.dyson.co.uk/register (UK) or www.dyson.ie/register (ROI).
- Telephone the Dyson Helpline.
- Complete the enclosed form and post it to us.

LIMITED 2 YEAR GUARANTEE

TERMS AND CONDITIONS OF THE DYSON 2 YEAR LIMITED GUARANTEE

WHAT IS COVERED

- The repair or replacement of your Dyson appliance (at Dyson's discretion) if it is found to be defective due to faulty materials, workmanship or function within 2 years of purchase or delivery (if any part is no longer available or out of manufacture Dyson will replace it with a functional replacement part).
- Where this machine is sold outside of the EU, this warranty

will only be valid if the appliance is used in the country in which it was sold.

- Where this machine is sold within the EU, this warranty will only be valid (i) if the appliance is used in the country in which it was sold or (ii) if the appliance is used in Austria, Belgium, France, Germany, Ireland, Italy, Netherlands, Spain or the United Kingdom and the same model as this appliance is sold at the same voltage rating in the relevant country.

WHAT IS NOT COVERED

Dyson does not guarantee the repair or replacement of a product where a defect is the result of:

- Accidental damage, faults caused by negligent use or care, misuse, neglect, carelessness or operation or handling of the appliance which is not in accordance with the Dyson Operating Manual.
- Use of the appliance for anything other than normal domestic household purposes.
- Use of parts not assembled or installed in accordance with the instructions of Dyson.
- Use of parts and accessories which are not genuine Dyson components.
- Faulty installation (except where installed by Dyson).
- Repairs or alterations carried out by parties other than Dyson or its authorised agents.
- Blockages – please refer to the Dyson Operating Manual for details of how to look for and clear blockages.
- Normal wear and tear (e.g. fuse, brush bar etc.).
- Use of this appliance on rubble, ash, plaster.
- Reduction in battery discharge time due to battery age or use (where applicable).

If you are in any doubt as to what is covered by your guarantee, please contact the Dyson Helpline.

SUMMARY OF COVER

- The guarantee becomes effective at the date of purchase (or the date of delivery if this is later).
- You must provide proof of (both the original and any subsequent) delivery/purchase before any work can be carried out on your Dyson appliance. Without this proof, any work carried out will be chargeable. Keep your receipt or delivery note.
- All work will be carried out by Dyson or its authorised agents.
- Any parts which are replaced by Dyson will become the property of Dyson.
- The repair or replacement of your Dyson appliance under guarantee will not extend the period of guarantee.
- The guarantee provides benefits which are additional to and do not affect your statutory rights as a consumer.

ABOUT YOUR PRIVACY

PRIVACY AND PERSONAL DATA PROTECTION

You will need to provide us with basic contact information when you register your Dyson Product or the Dyson Link App;

WHEN REGISTERING YOUR DYSON PRODUCT

You will need to provide us with basic contact information to register your product and enable us to support your

guarantee.

WHEN REGISTERING VIA THE DYSON LINK APP

You will need to provide us with basic contact information to register the Dyson Link App; this enables us to securely link your product to your instance of the App.

When you register, you will have the opportunity to choose whether you would like to receive communications from us. If you opt-in to communications from Dyson, we will send you details of special offers and news of our latest innovations. We never sell your information to third parties and only use information that you share with us as defined by our privacy policies which are available on our website. www.dyson.co.uk/support/privacypolicy.aspx

DYSON CUSTOMER CARE

Toll free

0800 298 0298

Monday to Friday 8am-8pm & Saturday and Sunday 8am-6pm

This Dyson appliance uses open source software, a full list of all the software and copyright notices together with the full licence terms can be found at www.dyson.com/360eyenotice. Changes may be made when the appliance's software is remotely updated, please see www.dyson.com/360eyenotice for up to date details

dyson

www.dysonrobot.com

