

ASSEMBLY

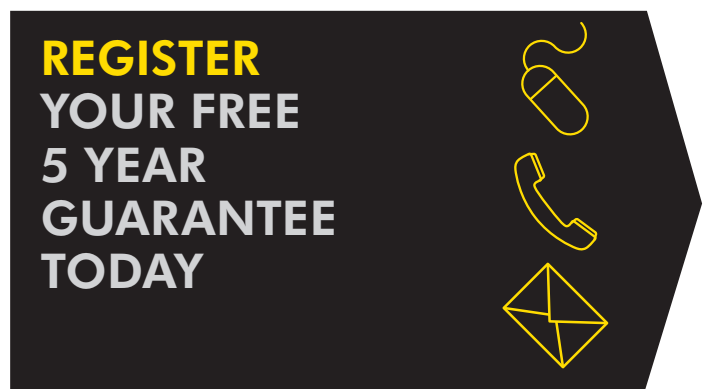
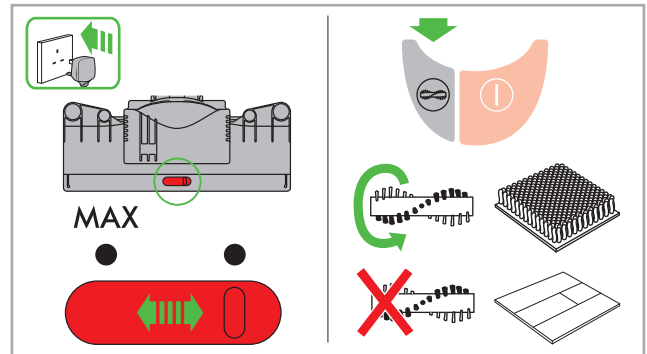
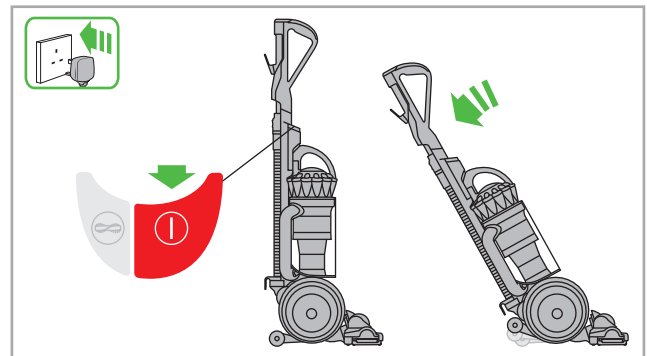
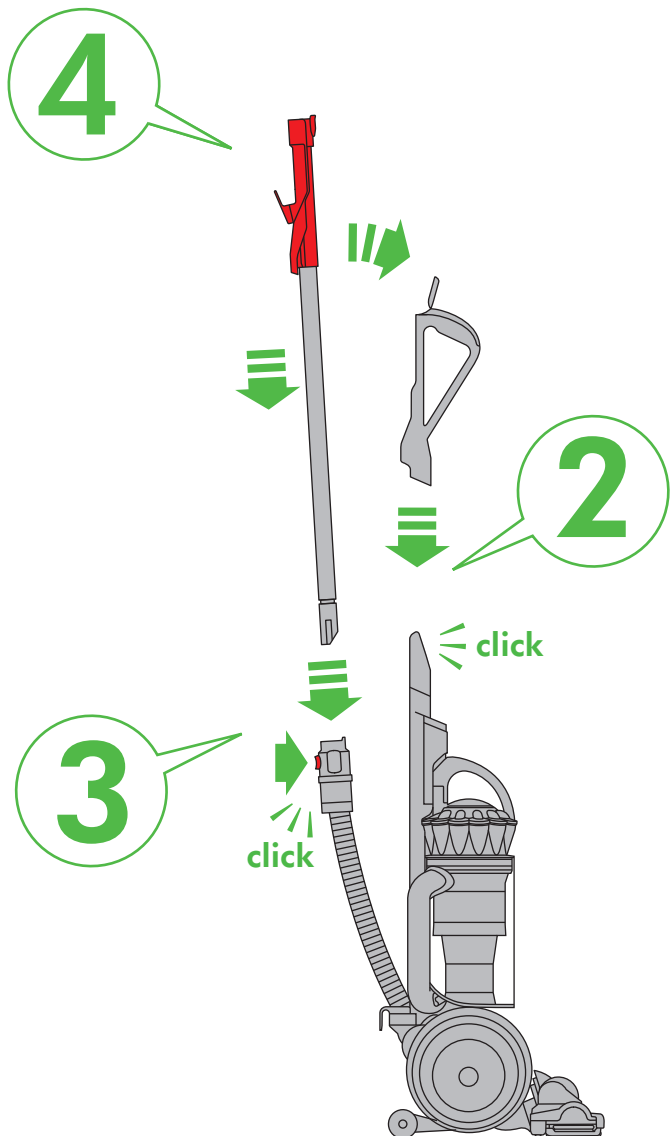
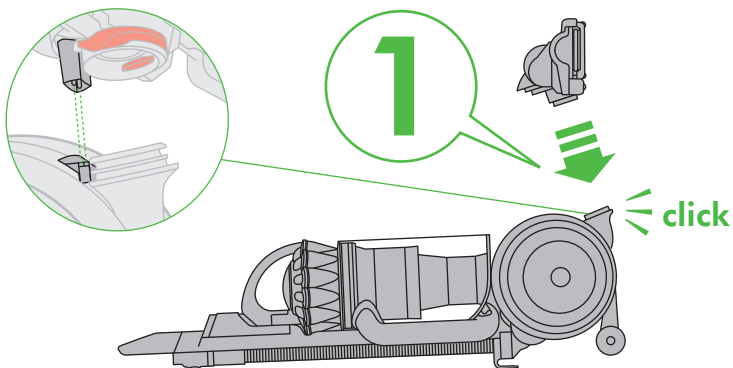

DYSON CUSTOMER CARE

THANK YOU FOR CHOOSING TO BUY A DYSON APPLIANCE

After registering your 5 year guarantee, your Dyson appliance will be covered for parts and labour for 5 years from the date of purchase, subject to the terms of the guarantee. If you have any questions about your Dyson appliance, call the Dyson Helpline with your serial number and details of where/when you bought the appliance. Most questions can be solved over the phone by one of our trained Dyson Helpline staff. Your serial number can be found on your rating plate which is on the base of the appliance. Alternatively, visit www.dyson.co.uk/support (UK) or www.dyson.ie/support (ROI) for online help, general tips and useful information about Dyson.

DYSON CONTACT DETAILS

UK:
Website: www.dyson.co.uk/support
Dyson Helpline: 0800 298 0298

Email: askdyson@dyson.co.uk

Address: Dyson Ltd, Tetbury Hill, Malmesbury, Wiltshire, SN16 0RP

ROI:
Website: www.dyson.ie/support
Dyson Helpline: 01 475 7109

Email: askdyson@dyson.co.uk

Address: Dyson Ireland Limited, Unit G10, Grants Lane, Greenogue Business Park, Rathcoole, Dublin 24

Note your serial number for future reference.

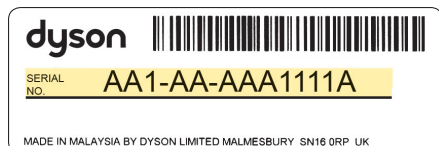

This illustration is for example purposes only.

3 EASY WAYS TO REGISTER YOUR FREE 5 YEAR GUARANTEE

REGISTER ONLINE



Visit our website to register your full parts and labour guarantee online.

www.dyson.co.uk/register
www.dyson.ie/register

REGISTER BY PHONE



Call our dedicated Helpline. Open Monday to Friday 8am-8pm & Saturday and Sunday 8am-6pm.

UK: 0800 298 0298
ROI: 01 475 7109

REGISTER BY MAIL



Complete and return the form to Dyson in the envelope supplied.

IMPORTANT SAFETY INSTRUCTIONS

BEFORE USING THIS APPLIANCE READ ALL INSTRUCTIONS AND CAUTIONARY MARKINGS IN THIS MANUAL AND ON THE APPLIANCE

When using an electrical appliance, basic precautions should always be followed, including the following:

WARNING

These warnings apply to the appliance, and also where applicable, to all tools, accessories, chargers or mains adaptors.

TO REDUCE THE RISK OF FIRE, ELECTRIC SHOCK, OR INJURY:

1. This Dyson appliance can be used by children aged from 8 years and above and persons with reduced physical, sensory or reasoning capabilities, or lack of experience and knowledge, only if they have been given supervision or instruction by a responsible person concerning use of the appliance in a safe way and understand the hazards involved. Cleaning and user maintenance shall not be made by children without supervision.
2. Do not allow to be used as a toy. Close attention is necessary when used by or near children. Children should be supervised to ensure that they do not play with the appliance.
3. Use only as described in this Dyson Operating Manual. Do not carry out any maintenance other than that shown in this manual, or advised by the Dyson Helpline.
4. Suitable for dry locations ONLY. Do not use outdoors or on wet surfaces.
5. Do not handle any part of the plug or appliance with wet hands.
6. Do not use with a damaged cable or plug. If the supply cable is damaged it must be replaced by Dyson, its service agent or similarly qualified person in order to avoid a hazard.
7. If the appliance is not working as it should, has received a sharp blow, has been dropped, damaged, left outdoors, or dropped into water, do not use and contact the Dyson Helpline.
8. Contact the Dyson Helpline when service or repair is required. Do not disassemble the appliance as incorrect reassembly may result in an electric shock or fire.
9. Do not stretch the cable or place the cable under strain. Keep the cable away from heated surfaces. Do not close a door on the cable, or pull the cable around sharp edges or corners. Arrange the cable away from traffic areas and where it will not be stepped on or tripped over. Do not run over the cable.
10. Do not unplug by pulling on the cable. To unplug, grasp the plug, not the cable. The use of an extension cable is not recommended.
11. Do not use to pick up water.
12. Do not use to pick up flammable or combustible liquids, such as petrol, or use in areas where they or their vapours may be present.
13. Do not pick up anything that is burning or smoking, such as cigarettes, matches, or hot ashes.
14. Keep hair, loose clothing, fingers, and all parts of the body away from openings and moving parts, such as the brush bar. Do not point the hose, wand or tools at your eyes or ears or put them in your mouth.
15. Do not put any object into openings. Do not use with any opening blocked; keep free of dust, lint, hair, and anything that may reduce airflow.
16. Use only Dyson recommended accessories and replacement parts.
17. To avoid a tripping hazard wind the cable when not in use.
18. Do not use without the clear bin and filters in place.
19. Do not leave the appliance when plugged in. Unplug when not in use and before servicing.
20. Do not pull or carry by cable or use cable as a handle.
21. Use extra care when cleaning on stairs. Do not work with the appliance above you on the stairs.
22. Turn off all controls before unplugging. Unplug before connecting any tool or accessory.

READ AND SAVE THESE INSTRUCTIONS

THIS DYSON APPLIANCE IS INTENDED FOR HOUSEHOLD USE ONLY

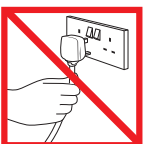

Do not pull on the cable.



Do not store near heat sources.



Do not use near naked flames.



Do not run over the cable.



Do not pick up water or liquids.

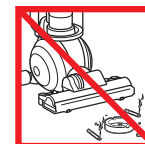

Do not pick up burning objects.

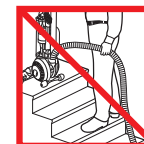

Do not use above you on the stairs.



Do not put hands near the brush bar when the appliance is in use.

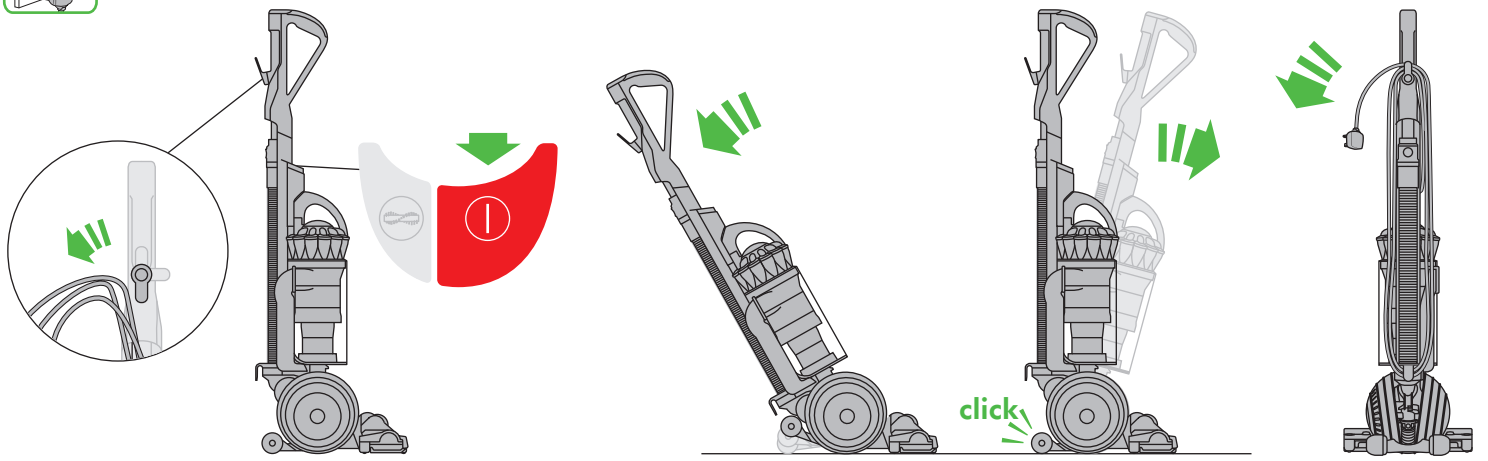

Emptying the clear bin

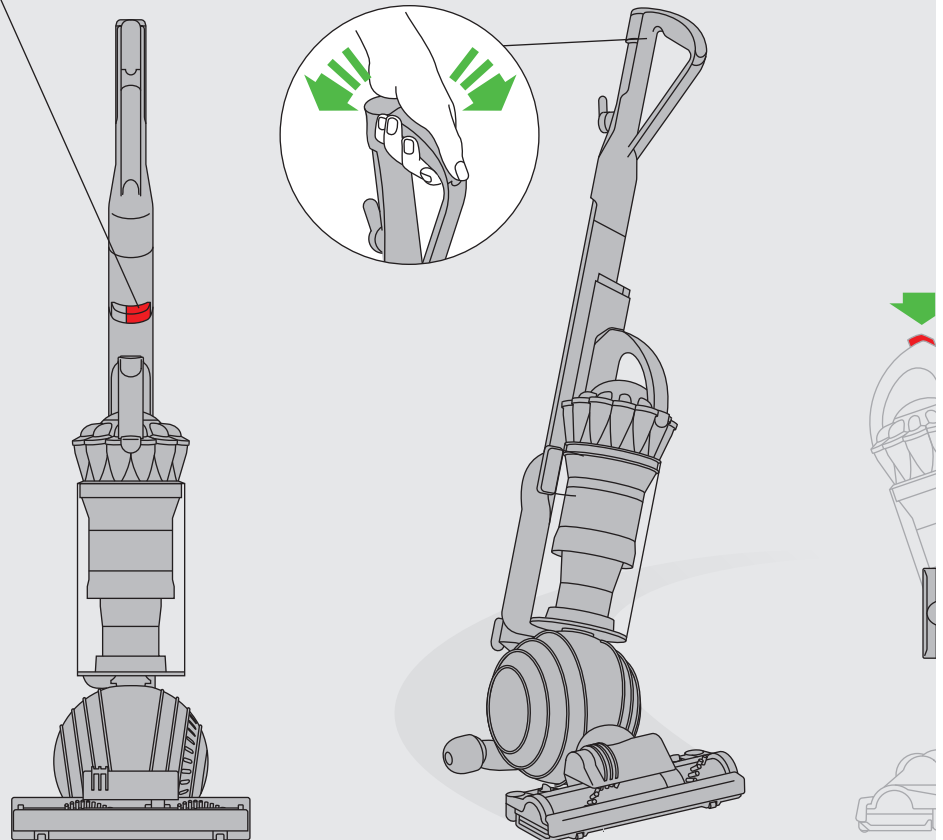
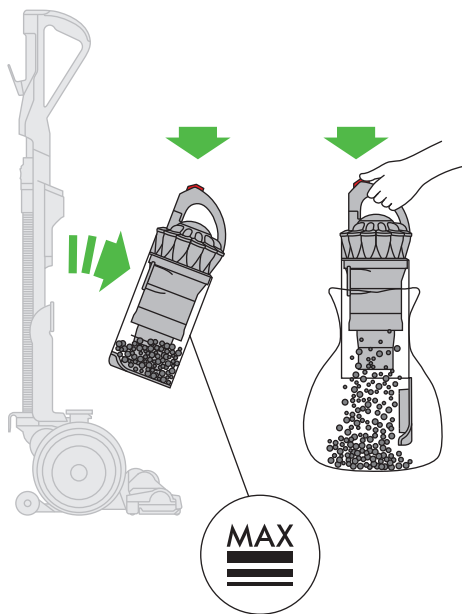
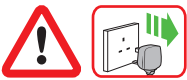

Looking for blockages

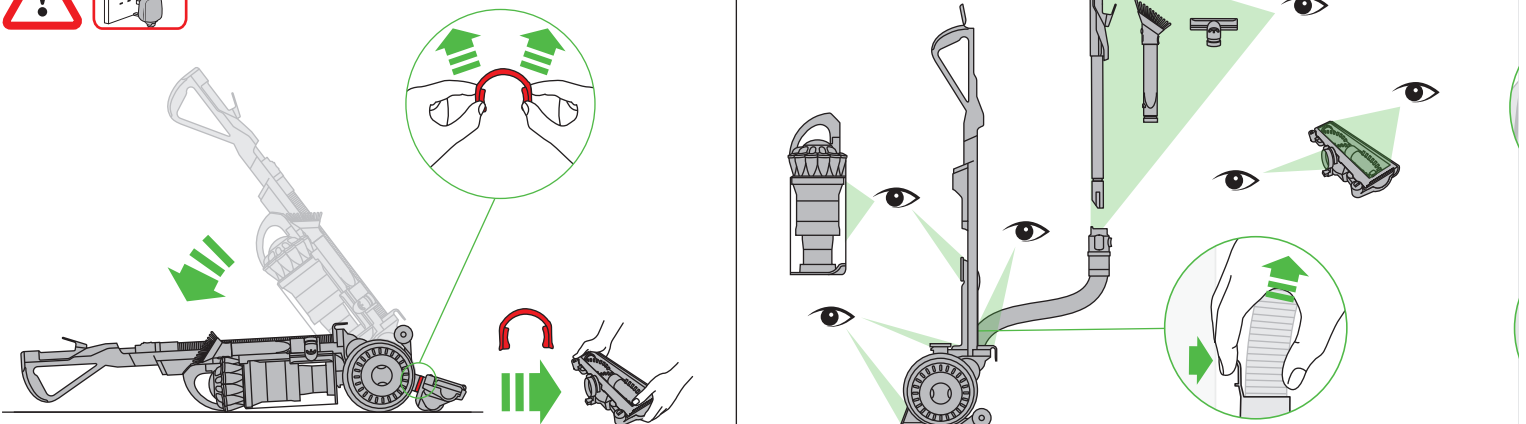

Carrying the appliance

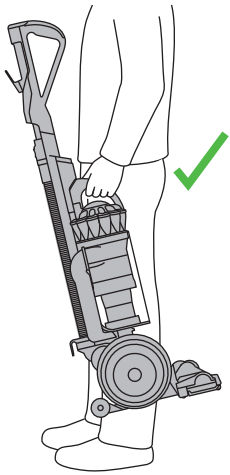

Carpets or hard floors

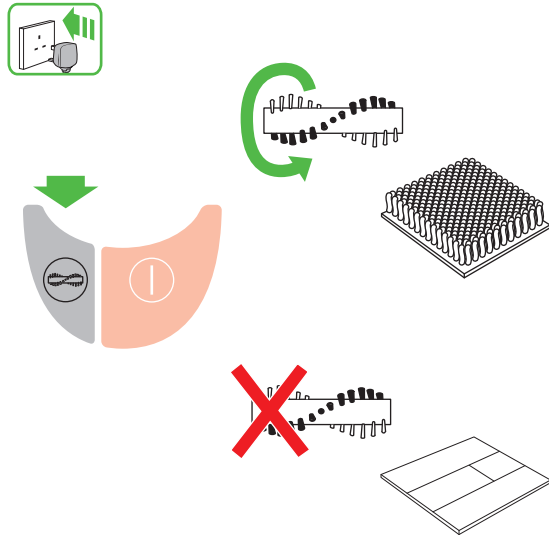

Tool attachments

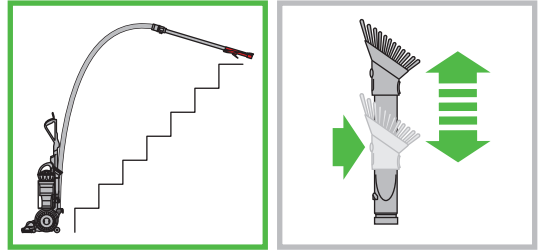

Self-adjusting cleaner head with suction control

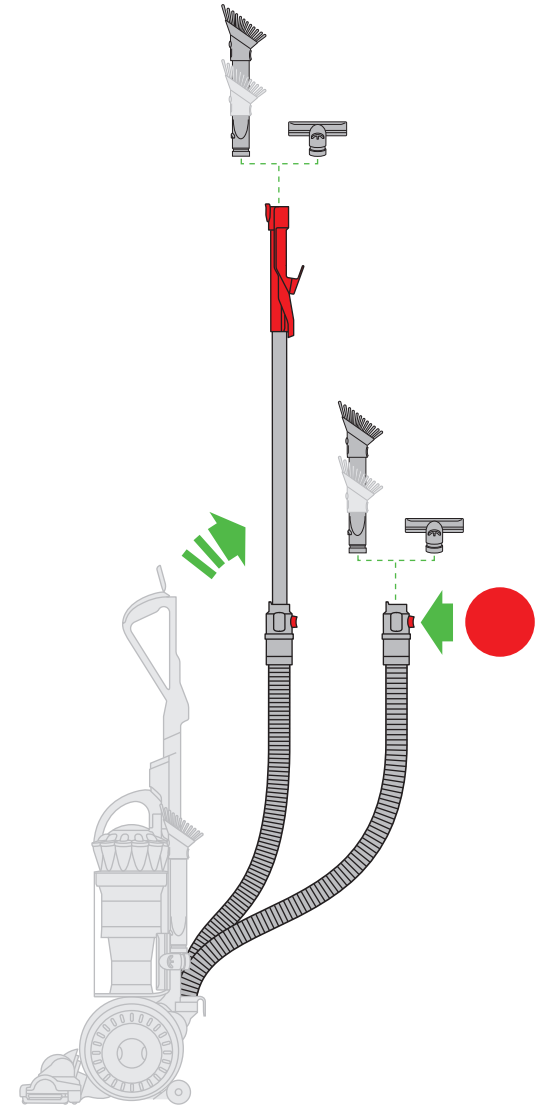
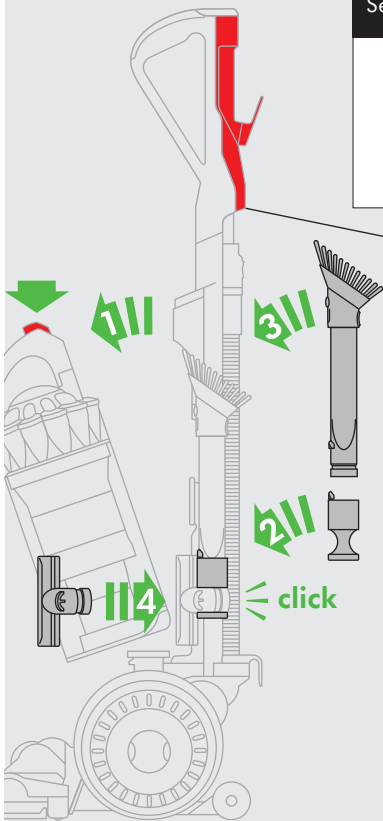
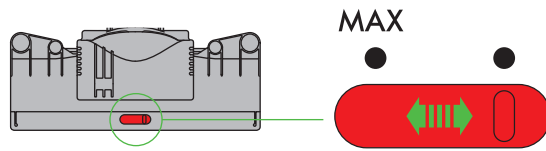

Brush bar – clearing obstructions

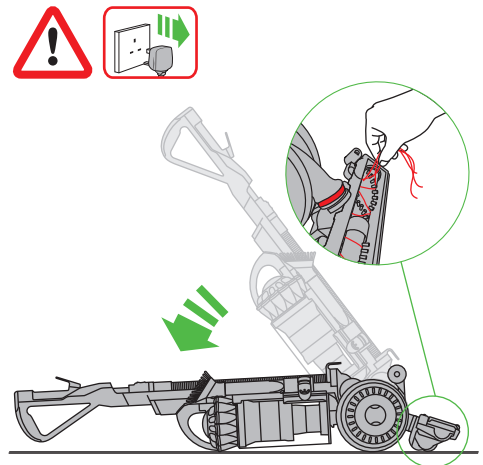
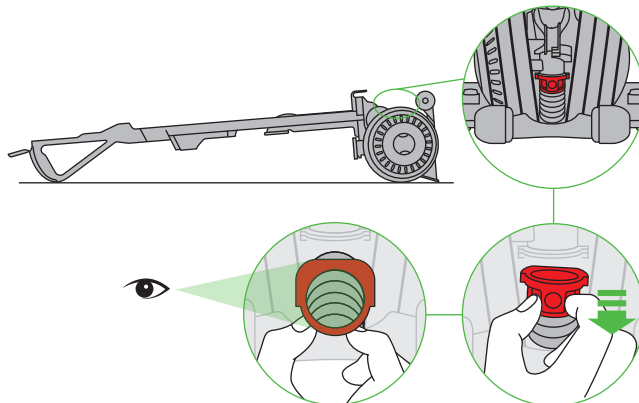
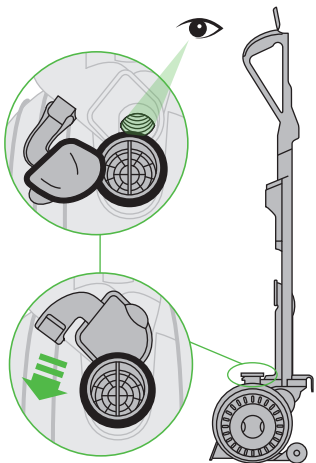

IMPORTANT!

WASH FILTERS

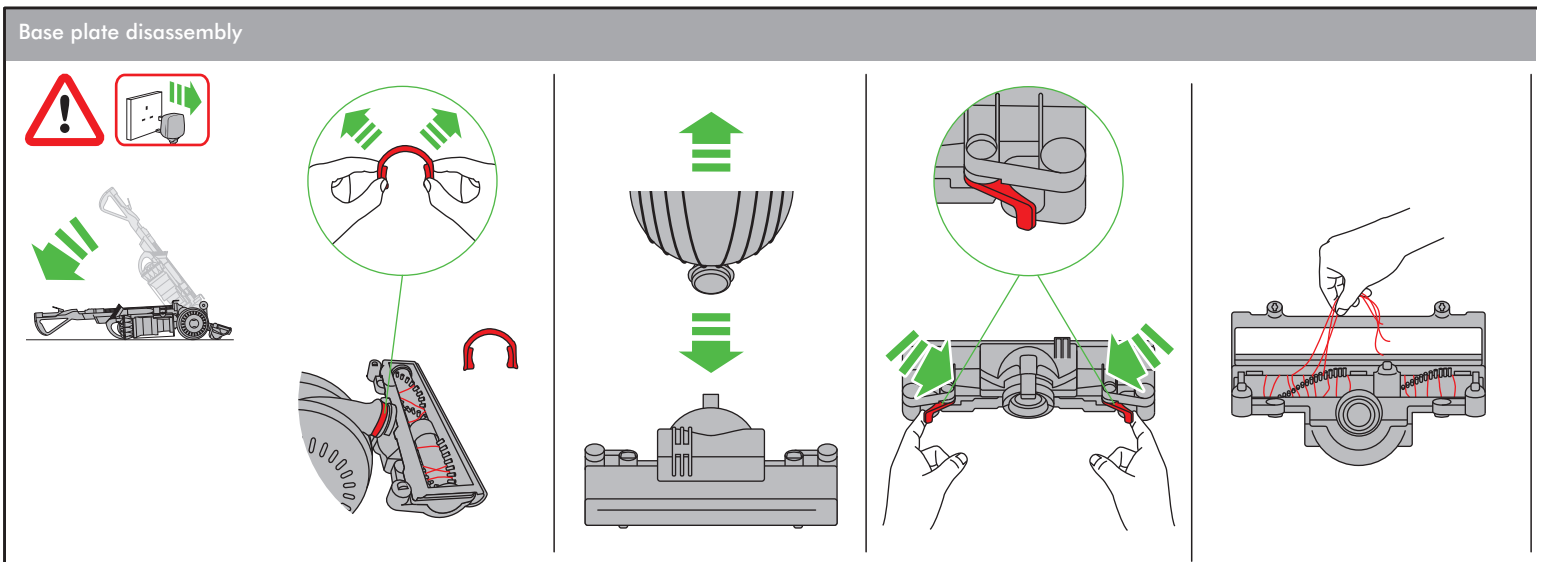
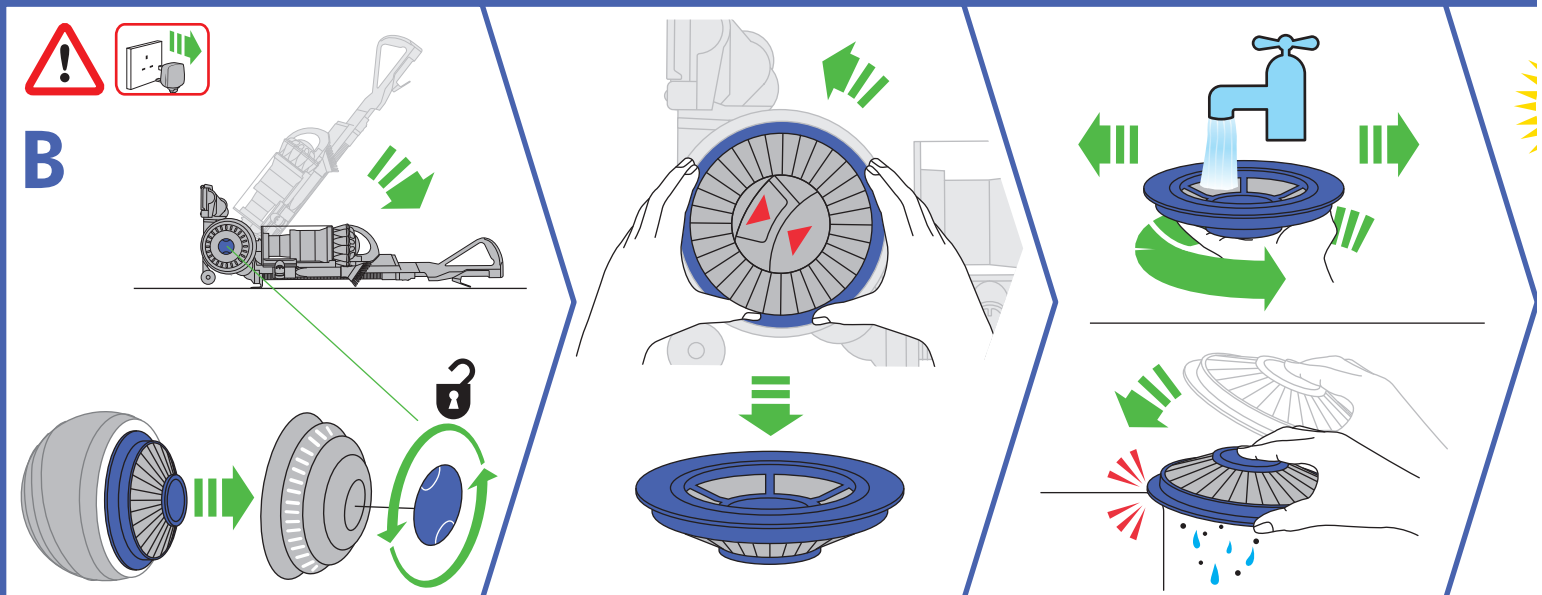
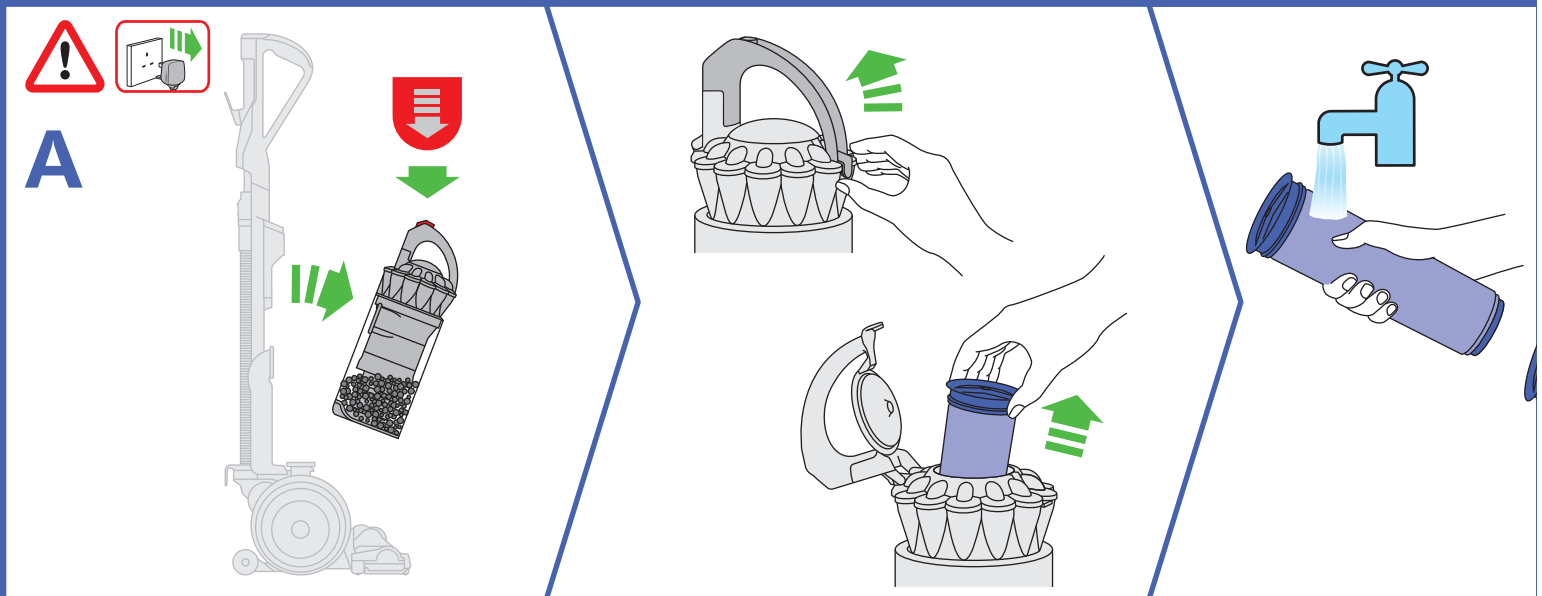

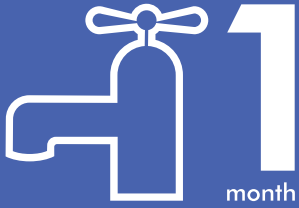

Wash filters with cold water at least every month.
The filters may require more frequent washing if vacuuming fine dust.

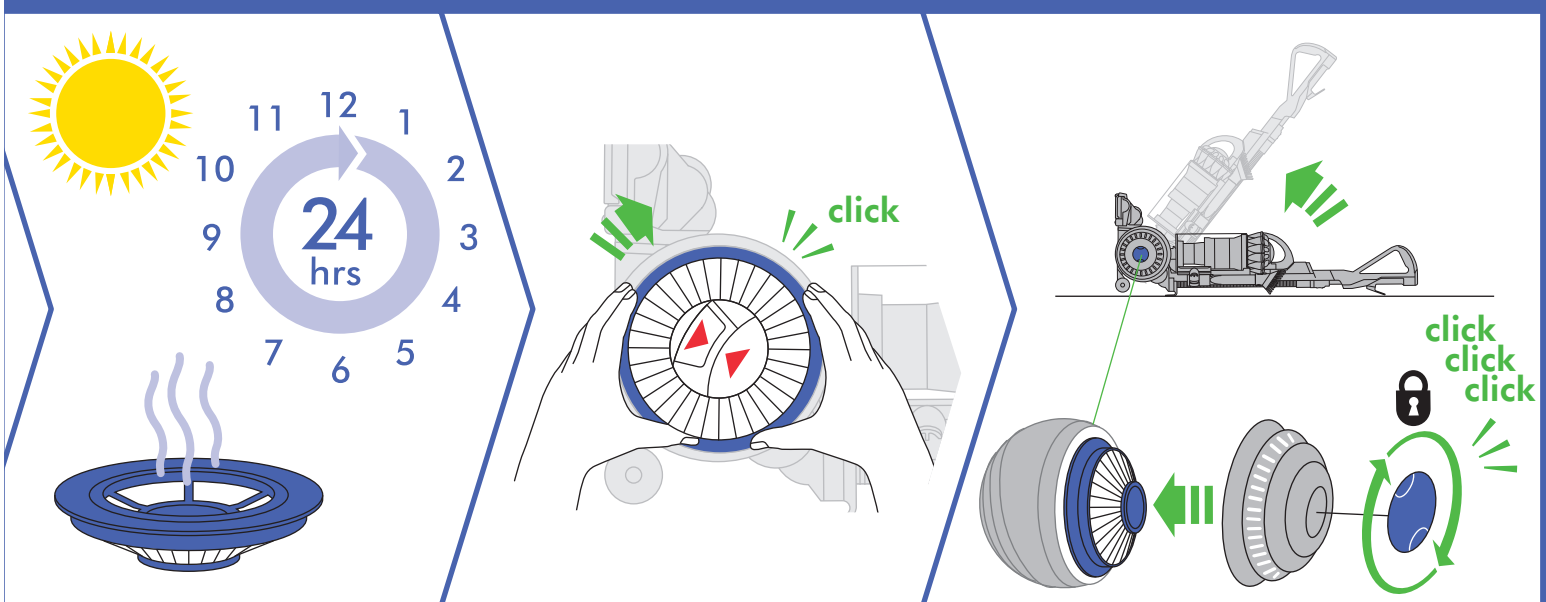
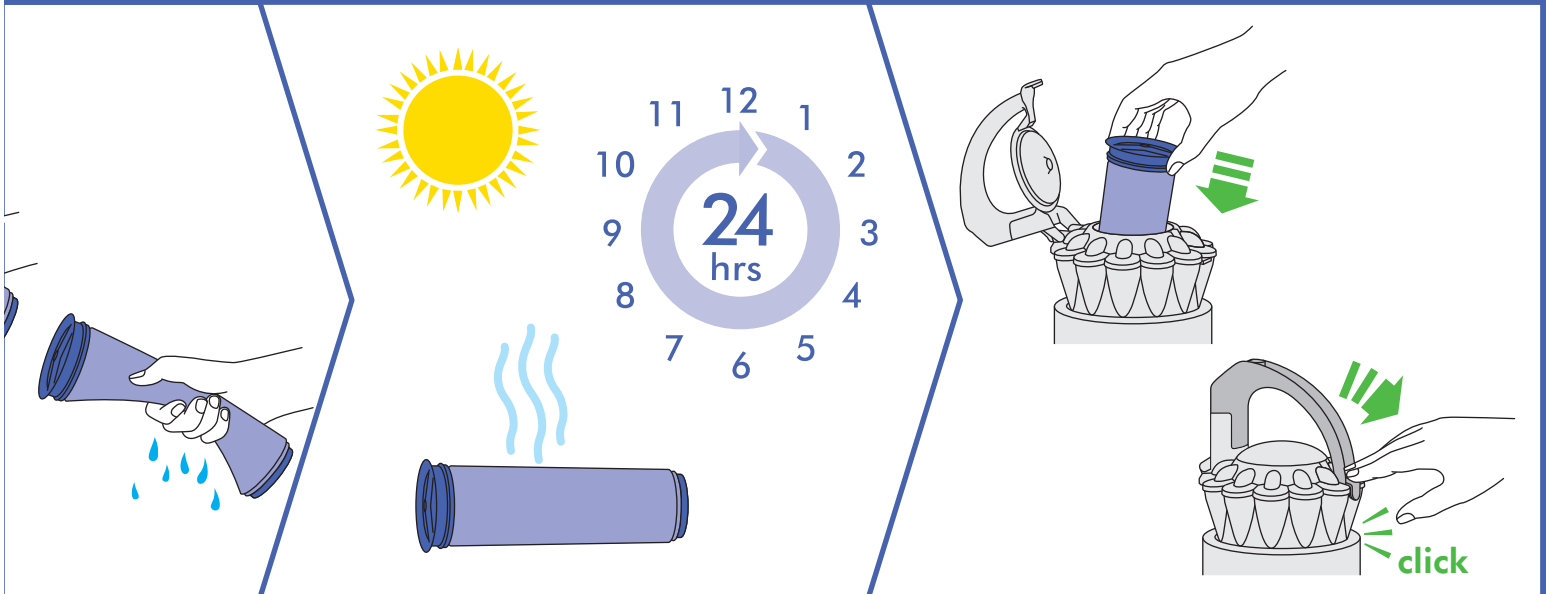

Base plate reassembly

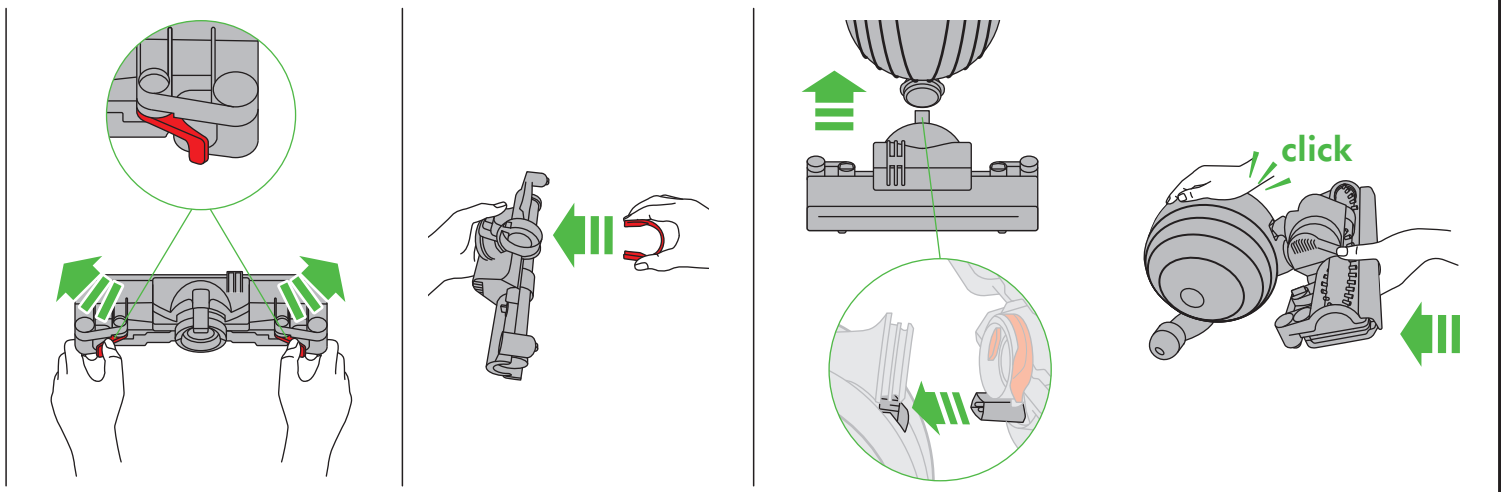

USING YOUR DYSON APPLIANCE

PLEASE READ THE 'IMPORTANT SAFETY INSTRUCTIONS' IN THIS DYSON OPERATING MANUAL BEFORE PROCEEDING.

ASSEMBLY

- Lie the appliance on its back.
- Attach the cleaner head by sliding it on to the connections on the lower front part of the ball. Ensure the electrical plug on the cleaner head fits into the twin - block connection on the body of the appliance, which is directly above the airway. Push firmly: the cleaner head will click into place.
- Stand the appliance up straight.
- Attach the wand handle by sliding it on to the top of the appliance. The spring clip in the handle will click into place.
- Ensure the hose is straight. Press the red button on the hose. Slide the wand into the hose.
- Ensure the wand and hose sit in the recess of the handle. Slide the end of the wand down into the handle to secure it.
- Close the wand cap.
- Slide the tool holder onto the side of the duct as shown.
- Ensure the cyclone and clear bin unit is secured to the main body of the appliance.
- Attach the tools as shown. In use, the tools can be attached to either the hose or the wand.
- Wind the cable around the cable hooks. Secure with the clip.
- To watch a short online video visit:
 - UK - www.dyson.co.uk/dc40gettingstarted
 - ROI - www.dyson.ie/dc40gettingstarted

OPERATION

- Unwind the cable.
- Plug the appliance into the mains electricity supply.
- To switch 'ON' or 'OFF' press the red power button, located as shown.
- To use, recline the handle. The stabiliser stand will automatically lift up.
- After use, return the appliance to the upright position, pushing it firmly into place. The stabiliser wheels will automatically lower.
- Then unplug the appliance, coil the cable safely and put the appliance away.
- Switch 'OFF' the appliance, unplug and ensure it is upright before:
 - changing or using tools
 - removing the hose or airway inspection parts.
- Use the cyclone carry handle to carry the machine.

SELF-ADJUSTING CLEANER HEAD WITH SUCTION CONTROL

- This cleaner head is used for testing with the European Regulations: No. 665/2013 and No. 666/2013.

POWERFUL SUCTION

- For vacuuming of lightly soiled carpets, rugs and hard flooring.
 - Your appliance is pre-set to this level of suction when you take it out of the box.

MAXIMUM SUCTION

- For vacuuming durable floor coverings, hard floors and heavily soiled carpets and rugs.
 - To switch to this setting, move the suction control slider on top of the cleaner head as shown.
 - CAUTION: The suction of this mode can damage delicate flooring. Before vacuuming, check the flooring manufacturer's cleaning recommendations.
 - If the suction power of Maximum suction prevents easy maneuverability, switch to Powerful suction mode.
 - To switch back to Powerful suction mode, move the suction control slider back to its original position, as shown.

CARPETS OR HARD FLOORS

- The brush bar will always default to 'ON' (spinning) each time you switch the appliance 'ON' and recline it for cleaning.
- The brush bar will not rotate when the appliance is upright.
- To switch the brush bar 'OFF' (e.g. for delicate rugs and delicate flooring):
 - switch the appliance 'ON'
 - recline the appliance
 - press the brush bar 'ON/OFF' button – the brush bar will stop spinning.
- The brush bar will automatically stop if it becomes obstructed. See 'Brush bar – clearing obstructions'.
- Before vacuuming your flooring, rugs and carpets, check the manufacturer's recommended cleaning instructions.
- Some carpets may fuzz if a rotating brush bar is used when vacuuming. If this happens, we recommend vacuuming with the brush bar switched 'OFF' and consulting with the flooring manufacturer.
- The brush bar on the appliance may damage some carpet types. If you are unsure, turn 'OFF' the brush bar.
- Check the brush bar regularly and clear away any debris (such as hair). Debris left on the brush bar may cause damage to flooring when vacuuming.

LOOKING AFTER YOUR DYSON APPLIANCE

- Do not carry out any maintenance or repair work other than that shown in this Dyson Operating Manual, or advised by the Dyson Helpline.
- Only use parts recommended by Dyson. If you do not this could invalidate your guarantee.
- Store the appliance indoors. Do not use or store it below 3°C (37.4°F). Ensure the appliance is at room temperature before operating.
- Clean the appliance only with a dry cloth. Do not use any lubricants, cleaning agents, polishes or air fresheners on any part of the appliance.
- If used in a garage, always wipe the base plate and ball with a dry cloth after vacuuming to clean off any sand, dirt, or pebbles that could damage delicate floors.

VACUUMING

- Do not use without the clear bin and filters in place.
- Fine dirt such as flour should only be vacuumed in very small amounts.
- Do not use the appliance to pick up sharp hard objects, small toys, pins, paper clips, etc. They may damage the appliance.
- When vacuuming, certain carpets may generate small static charges in the clear bin or wand. These are harmless and are not associated with the mains electricity supply. To minimise any effect from this, do not put your hand or insert any object into the clear bin unless you have first emptied it and rinsed it out with cold water (see 'Cleaning the clear bin').
- Do not work with the appliance above you on the stairs. When cleaning stairs it is recommended that the handle is not extended and that you use a tool on the end of the hose rather than the wand.
- Do not put the appliance on chairs, tables, etc.
- Before vacuuming highly polished floors, such as wood or lino, first check that the underside of the floor tool and its brushes are free from foreign objects that could cause marking.
- Do not leave the cleaner head in one place on delicate floors.

EMPTYING THE CLEAR BIN

- Empty as soon as the dirt reaches the level of the MAX mark – do not overfill.
- Switch 'OFF' and unplug before emptying the clear bin.
- To remove the cyclone and clear bin unit, press down on the red button on the top of the carrying handle on the cyclone.
- To release the dirt, press all the way down on the same red button on the top of the carrying handle on the cyclone.
- To minimise dust/allergen contact when emptying, encase the clear bin tightly in a plastic bag and empty.
- Remove the clear bin carefully from the bag.
- Seal the bag tightly, dispose as normal.
- To refit:
 - ensure the airway in the bin base is clear of dust and dirt
 - close the clear bin base so it clicks into place
 - push the cyclone and clear bin unit into the main body of the appliance; it will click into place
 - ensure the cyclone and clear bin unit is secure.

CLEANING THE CLEAR BIN

- Remove the cyclone and clear bin (see 'Emptying the clear bin').
- To separate the cyclone unit from the clear bin press the red button to open the clear bin base. This exposes a small silver button behind the red opening mechanism. Press the silver button (on its ribbed area) and separate the cyclone unit from the clear bin.
- Clean the clear bin with cold water only.
- Do not use detergents, polishes or air fresheners to clean the clear bin.
- Do not put the clear bin in a dishwasher.
- Do not immerse the whole cyclone in water or pour water into the cyclones.
- Clean the cyclone shroud with a cloth or dry brush to remove any lint and dust.
- Ensure the clear bin is completely dry before replacing.
- To refit:
 - fit the cyclone shroud into the clear bin so that the silver button clicks and engages
 - close the clear bin base so it clicks into place
 - push the cyclone and clear bin unit into the main body of the appliance; it will click into place
 - ensure the cyclone and clear bin unit is secure.

WASHING YOUR FILTERS

- Your appliance has two washable filters, located as shown.
- Check and wash the filters regularly according to instructions to maintain performance.
- Switch 'OFF' and unplug before checking or removing the filters.
- The filters may require more frequent washing if vacuuming fine dust.
- Wash with cold water only. Do not use detergents.
- Do not put the filters in a dishwasher, washing machine, tumble dryer, oven, microwave or near a naked flame.
- Filter A
 - Remove the cyclone and clear bin (see 'Emptying the clear bin').
 - Release the catch on the front of the cyclone handle and then remove the filter.
 - Wash the filter with cold water only. Hold under a tap and run water through the open end until the water runs clear. Turn upside down and tap out.
 - Squeeze and twist with both hands to make sure the excess water is removed.
 - Run water over the outside of the filter until the water runs clear.
 - Squeeze and twist with both hands to make sure the excess water is removed.
 - Stand the filter on its wide, open end to dry. Leave to dry completely for a minimum of 24 hours.
 - Replace the filter into the cyclone. Swing the handle back into place. Ensure the latch clicks to engage and is secure. Fit the cyclone and clear bin unit onto the appliance (instructions above).
- Filter B
 - Lie the appliance on its side.
 - To remove filter B:
 - turn the blue central locking dial on the outer cover of the ball anti-clockwise until the cover is released
 - lift off the cover
 - turn the filter one-quarter anti-clockwise to release.
 - Wash the filter with cold water only.
 - Filter B should be rinsed and tapped out until the water runs clear, then tapped out again to ensure all excess water is removed. (Tap on the plastic rim, not the filter material.) Leave to dry completely for a minimum of 24 hours.
 - It is normal for the filter in the ball to turn grey in colour.
 - To refit filter B:
 - refit the filter on to the ball
 - secure the filter by turning it clockwise so the white arrows align.
 - When refitting the outer cover of the ball, keep turning the central locking dial clockwise. When it starts to click it is locked.
 - To watch a short online video visit:
 - UK - www.dyson.co.uk/dc40filterwash
 - ROI - www.dyson.ie/dc40filterwash

BLOCKAGES – THERMAL CUT-OUT

- This appliance is fitted with an automatically resetting thermal cut-out.
- Large items may block the tools or wand inlet. If any part becomes blocked the appliance may overheat and automatically cut-out.
- If this happens, follow the instructions below in 'Looking for blockages'.

LOOKING FOR BLOCKAGES

- Switch 'OFF' and unplug before looking for blockages. Failure to do so could result in personal injury.
- Leave to cool down for 1-2 hours before checking the filters or for blockages.
- Clear any blockage before restarting.
- Look for blockages in the wand, airways and cleaner head.
- To release the hose from the machine, you will need to remove the wand.
- Open the wand release cap.
- Pull the wand up and away from the handle.
- Press the red release button in the connecting collar and remove the wand from the hose.
- Remove the clear bin and cyclone unit. Then release the hose from the appliance by pressing the red tab on the base of the hose – you can see it from the front of the appliance.
- Check for blockages in the hose.
- Beware of sharp objects when checking for blockages.
- To refit the hose, align the guides on the base of the hose with the channels in the neck of the airway. Ensure the red tab faces the front of the appliance. Push the hose on. It will click into place. To refit the wand follow the instructions above in the 'Operation' section.
- To remove the base plate to access an obstruction, see 'Base plate – disassembly/reassembly'.
- To look for blockages in the front airway between the ball and the cleaner head you will need to remove the cleaner head: see 'Base plate – disassembly/reassembly' below on how to do this.
- To look for blockages in the rear airway between the ball and the cleaner head you will need to release the hose. Hold and slide the red cuff out. Check thoroughly for blockages and slot back into place.
- Beware of sharp objects when checking for blockages.
- To look for blockages in the ball, open the clear plastic inlet on the top.
- Refit all parts securely before using.
- Clearing blockages is not covered by your guarantee.

BRUSH BAR – CLEARING OBSTRUCTIONS

- If your brush bar is obstructed, it may shut 'OFF'. If this happens, you will need to remove the blockage.
- Switch 'OFF' and unplug before proceeding. Failure to do so could result in personal injury.
- Beware of sharp objects when clearing obstructions.
- If you still cannot clear the obstruction, please follow the instructions below to remove the base plate. This gives more access to the obstruction. Alternatively, contact a Dyson expert on the Dyson Helpline or visit the website. Clearing brush bar obstructions is not covered by your guarantee.

BASE PLATE – DISASSEMBLY/REASSEMBLY

- Switch 'OFF' and unplug before proceeding. Failure to do so could result in personal injury.
- Lie the appliance on its front.
- Detach the red 'C' clip which is on the connection between the cleaner head and the appliance. It is quite firm, but do not pull it off roughly. Use a constant, firm pressure.
- Pull the cleaner head away from the appliance. Use a constant, firm pressure.
- At each end of the cleaner head there are 2 levers:
 - swing them out at right angles
 - hinge the base plate open.
- Beware of sharp objects when clearing obstructions.
- To refit the base plate, hinge it closed.
- To secure the base plate push both levers back into position so they are flush with the surface of the cleaner head.
- Refit the red 'C' clip onto the cleaner head. The flatter edge of the clip fits against the cleaner head. It is easier to slide one leg into its slot before the other.
- Lay the appliance on its back.
- Attach the cleaner head by sliding it on to the connections on the lower front part of the ball. Ensure the electrical plug on the cleaner head fits into the twin - block connection on the body of the appliance, which is directly above the airway. Push firmly: the cleaner head will click into place.

BRUSH BAR – TROUBLESHOOTING

- If the brush bar has stopped spinning, follow the instructions above on clearing obstructions. Alternatively, contact a Dyson expert on the Dyson Helpline or visit the website.
- To view a short online video visit:
 - UK - www.dyson.co.uk/dc40brushbarmaintenance
 - ROI - www.dyson.ie/dc40brushbarmaintenance

DISPOSAL INFORMATION

- Dyson products are made from high grade recyclable materials. Recycle where possible.



This marking indicates that this product should not be disposed with other household wastes throughout the EU. To prevent possible harm to the environment or human health from uncontrolled waste disposal, recycle it responsibly to promote the sustainable reuse of material resources. To return your used device, please use the return and collection systems or contact the retailer where the product was purchased. They can take this product for environmentally safe recycling.

GUARANTEE TERMS AND CONDITIONS

DYSON CUSTOMER CARE

THANK YOU FOR CHOOSING TO BUY A DYSON APPLIANCE

After registering your 5 year guarantee, your Dyson appliance will be covered

for parts and labour for 5 years from the date of purchase, subject to the terms of the guarantee. If you have any questions about your Dyson appliance, call the Dyson Helpline with your serial number and details of where/when you bought the appliance. Most questions can be solved over the phone by one of our trained Dyson Helpline staff.

Alternatively, visit www.dyson.co.uk/support (UK) or www.dyson.ie/support (ROI) for online help, general tips and useful information about Dyson.

If your Dyson appliance needs a service, call the Dyson Helpline so we can discuss the available options. If your Dyson appliance is under guarantee, and the repair is covered, it will be repaired at no cost.

Your serial number can be found on your rating plate which is behind the clear bin.

PLEASE REGISTER AS A DYSON APPLIANCE OWNER

To help us ensure you receive prompt and efficient service, please register as a Dyson appliance owner. There are three ways to do this:

- Online at www.dyson.co.uk/register (UK) or www.dyson.ie/register (ROI).
 - Telephone the Dyson Helpline on 0800 298 0298 (UK) or 01 475 7109 (ROI).
 - Complete the enclosed form and post it to us.
- This will confirm ownership of your Dyson appliance in the event of an insurance loss, and enable us to contact you if necessary.

LIMITED 5 YEAR GUARANTEE

TERMS AND CONDITIONS OF THE DYSON 5 YEAR LIMITED GUARANTEE.

WHAT IS COVERED

- The repair or replacement of your Dyson machine (at Dyson's discretion) if it is found to be defective due to faulty materials, workmanship or function within 5 years of purchase or delivery (if any part is no longer available or out of manufacture Dyson will replace it with a functional replacement part).
- Where this machine is sold outside of the EU, this warranty will only be valid if the appliance is used in the country in which it was sold.
- Where this machine is sold within the EU, this warranty will only be valid (i) if the appliance is used in the country in which it was sold or (ii) if the appliance is used in Austria, Belgium, France, Germany, Ireland, Italy, Netherlands, Spain or the United Kingdom and the same model as this appliance is sold at the same voltage rating in the relevant country.

WHAT IS NOT COVERED

Dyson does not guarantee the repair or replacement of a product where a defect is the result of:

- Accidental damage, faults caused by negligent use or care, misuse, neglect, carelessness or operation or handling of the appliance which is not in accordance with the Dyson Operating Manual.
- Use of the appliance for anything other than normal domestic household purposes.
- Use of parts not assembled or installed in accordance with the instructions of Dyson.
- Use of parts and accessories which are not genuine Dyson components.
- Faulty installation (except where installed by Dyson).
- Repairs or alterations carried out by parties other than Dyson or its authorised agents.
- Blockages – please refer to the Dyson Operating Manual for details of how to look for and clear blockages.
- Normal wear and tear (e.g. fuse, brush bar etc.).
- Use of this appliance on rubble, ash, plaster.
- Reduction in battery discharge time due to battery age or use (where applicable).

If you are in any doubt as to what is covered by your guarantee, please contact the Dyson Helpline.

SUMMARY OF COVER

- The guarantee becomes effective at the date of purchase (or the date of delivery if this is later).
- You must provide proof of (both the original and any subsequent) delivery/purchase before any work can be carried out on your Dyson appliance. Without this proof, any work carried out will be chargeable. Keep your receipt or delivery note.
- All work will be carried out by Dyson or its authorised agents.
- Any parts which are replaced by Dyson will become the property of Dyson.
- The repair or replacement of your Dyson appliance under guarantee will not extend the period of guarantee.
- The guarantee provides benefits which are additional to and do not affect your statutory rights as a consumer.

ABOUT YOUR PRIVACY

- Your information will be held by Dyson and its agents for promotional, marketing and servicing purposes.
- If your personal details change, if you change your mind about any of your marketing preferences or if you have any queries about how we use your information, please contact the Dyson Helpline.
- For more information on how we protect your privacy, please see our privacy policy on the Dyson website.

IMPORTANT!

WASH FILTERS

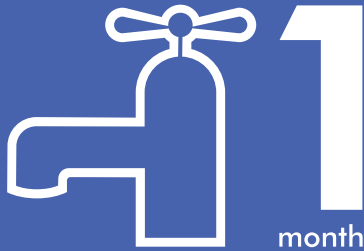

Wash filters with cold water at least every month.
The filters may require more frequent washing if vacuuming fine dust.



After registering your 5 year guarantee, your Dyson appliance will be covered for parts and labour for 5 years from the date of purchase, subject to the terms of the guarantee. If you have any questions about your Dyson appliance, call the Dyson Helpline with your serial number and details of where/when you bought the appliance. Most questions can be solved over the phone by one of our trained Dyson Helpline staff.

DYSON CONTACT DETAILS

UK:

Website: www.dyson.co.uk/support

Dyson Helpline: 0800 298 0298

Email: askdyson@dyson.co.uk

Address: Dyson Ltd, Tetbury Hill, Malmesbury, Wiltshire, SN16 0RP

ROI:

Website: www.dyson.ie/support

Dyson Helpline: 01 475 7109

Email: askdyson@dyson.co.uk

Address: Dyson Ireland Limited, Unit G10, Grants Lane, Greenogue Business Park, Rathcoole, Dublin 24



Serial number

Date of purchase / / Country of purchase UK ROI

Title Surname

First name

Address

Postcode

e-mail

Telephone Mobile

As a Dyson vacuum cleaner owner, you can hear about Dyson inventions, services and products before anyone else. If it's okay to contact you, please let us know how we may do this.

By mail Yes No

By phone Yes No

By email Yes No

By text message Yes No

We sometimes ask other companies (such as market researchers) to contact owners on our behalf. We do this to get feedback on ideas or ask you to try new products and services. Would this be okay?

Yes No

3 EASY WAYS TO REGISTER YOUR FREE 5 YEAR GUARANTEE



REGISTER ONLINE

Visit our website to register your full parts and labour guarantee online.

www.dyson.co.uk/register
www.dyson.ie/register



REGISTER BY PHONE

Call our dedicated Helpline. Open Monday to Friday 8am-8pm & Saturday and Sunday 8am-6pm.

UK: 0800 298 0298
ROI: 01 475 7109



REGISTER BY MAIL

Complete and return the form to Dyson in the envelope supplied.

