

dyson airwrap

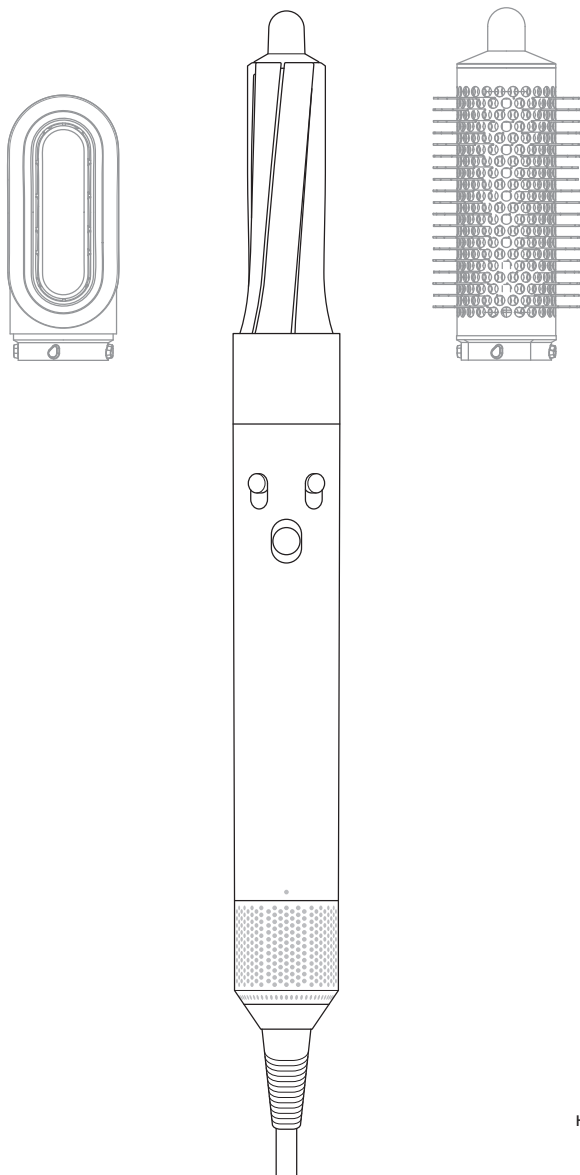

HS01

HK

捷成消費品服務中心(香港)

pidcs@jebsen.com

(852) 2926 2300

香港九龍旺角太子道西193號新世紀廣場2座18樓1815室

www.dyson.hk

ID

cs.dyson@e-metrox.com

+62 21 2788 3555 (ext. 3222) | +62 21 5082 2950

+62 81211761750 (Call & WhatsApp)

PT. Metrox Mekanika

Satrio Tower, 21st Floor

Jl. Prof. Dr Satrio Kav. C4

Kel. Kuningan Timur, Kec. Setiabudi

Jakarta 12950

www.dyson.co.id

KR

다이슨 고객센터

help@kr.dyson.com

1588 4253

MY

Dyson Helpline

+603 7969 1313

dysoncs@dancom.com.my

A-11-P1, Jaya One, 72A Jalan Universiti, 46200 Petaling Jaya,

Selangor, Malaysia.

www.dyson.my

PH

Whiteplane, Inc.

dysonservice@wpi.ph

21/F Taipan Place F. Ortigas Jr. Road, Ortigas Center, Pasig City

1605 Philippines

+632 8451 1111

www.dyson.ph

SG

Dyson Customer Care

1800-3976674

www.dyson.com.sg

13 Stamford Road Capitol Piazza

#01-15/16/24/25 Singapore 178905

TH

ศูนย์บริการลูกค้า Dyson

บริษัท เซ็นทรัล เทรดดิ้ง จำกัด (สำนักงานใหญ่)

ask.dyson@cmg.co.th

+66 2026 6325

ชั้น 6 อาคารสิรินรัตน์ 3388/25-37 ถ.พระราม 4 แขวงคลองตัน เขตคลองเตย
กรุงเทพฯ 10110

TW

戴森消費者服務中心

service@hlh.com.tw

0800 251 209

台灣區獨家總代理

恆隆行貿易股份有限公司

台北市內湖區洲子街 88 號 7 樓

www.dyson.tw

VN

General Trading Fashions One Member Company Limited

163 Phan Dang Luu, Ward 01, Phu Nhuan District,

Ho Chi Minh, Vietnam.

EN

Contents

- 7 Important safety instructions
- Getting started**
- 10 In the box
- 11 Functions
- 12 Using your attachments
- 14 **Regular filter maintenance**
- 16 Additional information

Thank you for buying the Dyson Airwrap™ styler.

By combining our small, powerful digital motor with applied aerodynamics, the Dyson Airwrap™ styler is able to harness the Coanda effect. This allows it to style and dry simultaneously, using air – without extreme heat.

How to curl your hair with Coanda air.
Watch the 30sec film

Scan with phone camera or app, or visit
www.dyson.com/myairwrap



Registration

After registering your 2 year guarantee, your Dyson appliance will be covered for parts and labour for 2 years from the date of purchase, subject to the terms of the guarantee.

If you have any questions about your Dyson appliance, call the Dyson Helpline with your serial number and details of where and when you bought the appliance.

Most questions can be solved over the phone by one of our trained Dyson Helpline staff.

Visit www.dyson.com/support for online help, support videos, general tips and useful information about Dyson.

Your 2 year guarantee is based on 'normal use'. It does not apply to use in salons or by stylists.

Your serial number can be found on the rating plate located on the cable label, towards the plug.

Note your serial number for future reference on the back page of this manual.

This illustration is for example purposes only.



EN

IMPORTANT SAFETY INSTRUCTIONS

Read all instructions before use

When using an electrical appliance, basic precautions should always be followed, including the following:

WARNING

These warnings apply to the appliance, and also where applicable, to all tools, accessories, chargers or mains adaptors.

To reduce the risk of fire, electric shock, or injury:

1. This appliance can be used by children aged from 8 years and above and persons with reduced physical, sensory or reasoning capabilities, or lack of experience and knowledge, only if they have been given supervision or instruction by a responsible person concerning use of the appliance in a safe way and understand the hazards involved. Cleaning and user maintenance shall not be made by children without supervision.
2. Do not allow to be used as a toy. Close attention is necessary when used by or near children. Children should be supervised to ensure that they do not play with the appliance.

3. If the appliance is used in a bathroom, unplug after use. The proximity of water presents a hazard even when the appliance is switched off.



4. **WARNING:** Do not use this appliance near bathtubs, showers, basins or other vessels containing water.
5. If the supply cord is damaged, it must be replaced or repaired by the manufacturer, its service agent or similarly qualified persons in order to avoid a hazard.
6. This appliance has a non-self resetting thermal cut-out safety device to prevent overheating. If your appliance cuts out, unplug it from the mains supply socket and leave to cool.
7. **CAUTION:** In order to avoid a hazard due to inadvertent resetting of the thermal cut-out, this appliance must not be supplied through an external switching device, such as a timer, or connected to a circuit that is regularly switched on and off by the utility company, or plugged into any socket where the electrical supply is unstable or likely to be turned off.
8. For additional protection, the installation of a residual current device (RCD) having a rated residual operating current not exceeding 30mA is advisable. Ask your installer for advice.

9. Do not use the appliance for any other purpose than styling hair.
10. Do not handle any part of the plug or appliance with wet hands.
11. Do not unplug by pulling on the cable or stretch or pull the cable when in use. Do not use an extension lead and do not wrap the cable around the appliance.
12. Do not use any lubricants, cleaning agents, polishes or air fresheners on any part of the appliance.
13. Contact the Dyson Helpline when a service or repair is required. Do not disassemble the appliance as incorrect reassembly may result in an electric shock or fire.
14. If the appliance is not working as it should, if it has received a sharp blow, if it has been dropped, damaged, left outdoors, or dropped into water, do not use and contact the Dyson Helpline.
15. For best results, the appliance should be used with the recommended attachments. However, it can be used without an attachment.
16. For the rated power, it is determined without attachments.



The attachments may become hot during use.

In the box

Dyson Airwrap™
styler main body

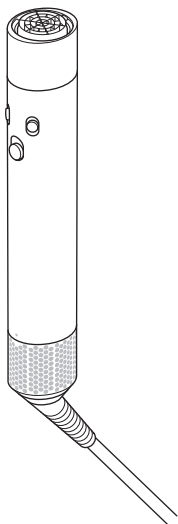

Pre-styling dryer

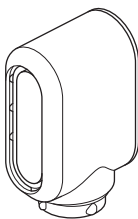

Non-slip mat



Filter cleaning brush

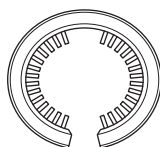

Some attachments may not be included.

Attachments can be purchased separately at
www.dyson.com/myairwrap.

Airwrap™
barrels

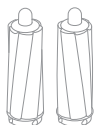

10

Firm
smoothing
brush

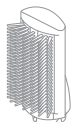

Soft
smoothing
brush

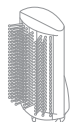

Round
volumising
brush



Functions

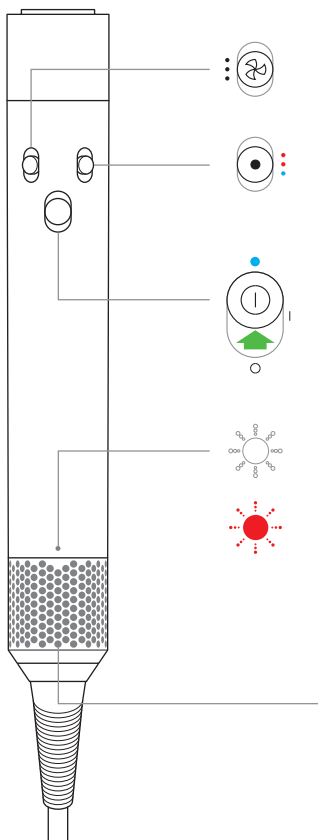

Airflow control
3 airflow speeds.

Temperature control
2 heat settings plus a cold setting to finish your style.

Power on/off with cold shot
Sliding switch with cold shot to set your style.

LED
Clean the filter. See the 'Regular filter maintenance' section for details.

If the red LED lights, and the filter has already been cleaned, contact the Dyson Helpline.

Removable filter cage
Easy to remove for cleaning (see the 'Regular filter maintenance' section for details).

Using your attachments

Connecting the attachment

Turn attachment into the main body until it fits securely.

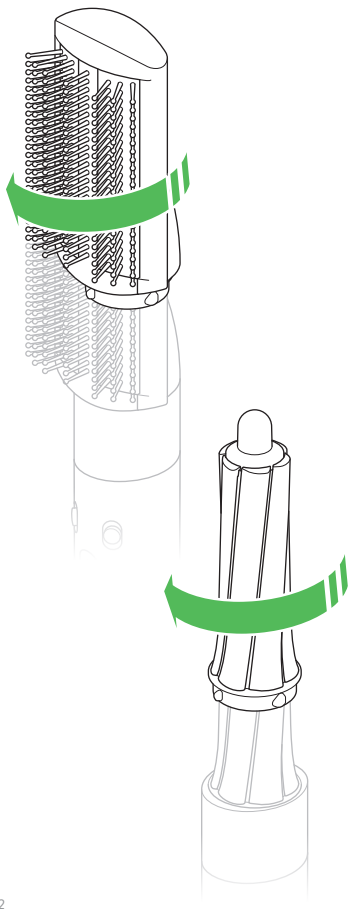

Changing attachments

To change attachment, pull down on the switch to release.

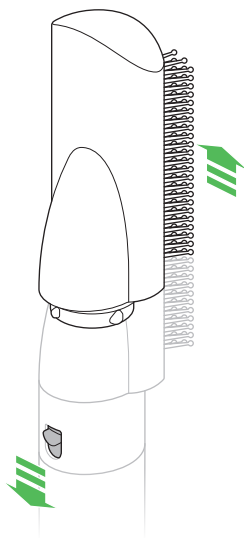

Cool tip

During use, the curlers and round volumising brush will get hot.

To change to another attachment, hold the tip.

Take care when handling hot attachments

Hold the attachment only in the area indicated.

Some attachments may need occasional cleaning.

For more information, go to www.dyson.com/myairwrap.

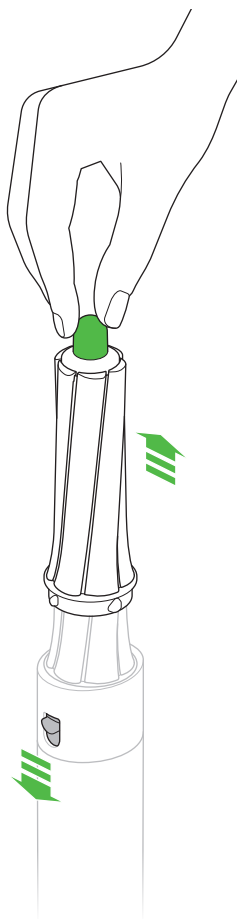

Pre-styling dryer



Airwrap™ barrels



Firm smoothing brushes



Soft smoothing brushes

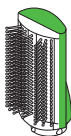

Round volumising brush



Regular filter maintenance

The filter must be cleaned when the white LED starts flashing.

Ensure that you unplug your machine from the mains electricity supply and allow to cool down before cleaning your filter.

This technology needs to be kept free from dust and hair product residue and maintenance is required to maintain performance.

The Dyson Airwrap™ styler has highly tuned technology to give outstanding performance.

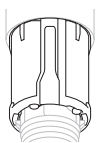

Filter mesh

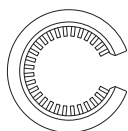

Filter cleaning brush

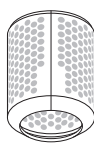

Filter cage

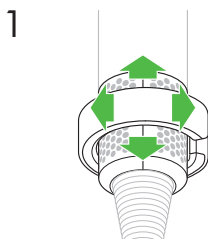

Slide the filter cleaning brush over the cable and onto the filter cage.

Using a rotating action clean the filter cage thoroughly.

Remove the filter cleaning brush.

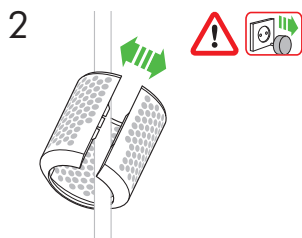

Hold the handle of your appliance and pull the filter cage downwards, onto the cable.

Gently pull open the filter cage and slide it off the cable.

3

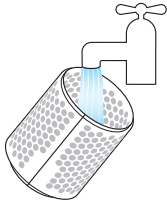

Wash the filter cage under a warm, running tap.

4

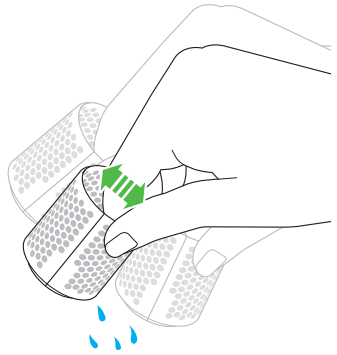

Shake the filter cage to remove the majority of the excess water, then leave to dry well naturally.

5



Using a rotating and up and down action, clean the filter mesh with the filter cleaning brush until all the debris has been removed.

Do not use water or chemicals to clean the filter mesh.

6



Gently pull the filter cage open and slide it onto the cable.

Slide the filter cage towards the handle and twist until it snaps into place.



Do not use your appliance without the filter cage attached.

Additional information

EN

LIMITED 2 YEAR GUARANTEE

TERMS AND CONDITIONS OF THE DYSON 2 YEAR LIMITED GUARANTEE

WHAT IS COVERED

- The repair or replacement of your Dyson appliance (at Dyson's discretion) if it is found to be defective due to faulty materials, workmanship or function within 2 years of purchase or delivery (if any part is no longer available or out of manufacture Dyson will replace it with a functional replacement part).
- Where this appliance is sold outside of the EU, this guarantee will only be valid if the appliance is used in the country in which it was sold.

WHAT IS NOT COVERED

Dyson does not guarantee the repair or replacement of a product where a defect is the result of:

- Damage caused by not carrying out the recommended appliance maintenance.
 - Accidental damage, faults caused by negligent use or care, misuse, neglect, carelessness or operation or handling of the appliance which is not in accordance with the Dyson Operating Manual.
 - Use of the appliance for anything other than the use it is designed for.
 - Use of the appliance outside of "normal use".
 - Use of the appliance in salons or by stylists.
 - Use of parts not assembled or installed in accordance with the instructions of Dyson.
 - Use of parts and accessories which are not genuine Dyson components.
 - Faulty installation (except where installed by Dyson).
 - Repairs or alterations carried out by parties other than Dyson or its authorised agents.
 - Normal wear and tear (e.g. fuse etc.).
- If you are in any doubt as to what is covered by your guarantee, please contact the Dyson Helpline.

SUMMARY OF COVER

- The guarantee becomes effective from the date of purchase (or the date of delivery if this is later).
- You must provide proof of (both the original and any subsequent) delivery/purchase before any work can be carried out on your Dyson appliance. Without this proof, any work carried out will be chargeable. Keep your receipt or delivery note.
- All work will be carried out by Dyson or its authorised agents.
- Any parts which are replaced by Dyson will become the property of Dyson.
- The repair or replacement of your Dyson appliance under guarantee will not extend the period of guarantee.
- The guarantee provides benefits which are additional to and do not affect your statutory rights as a consumer.

IMPORTANT DATA PROTECTION INFORMATION

- Your information will be held by Dyson and its agents for promotional, marketing and servicing purposes.
- If your personal details change, if you change your mind about any of your marketing preferences or if you have any queries about how we use your information, please contact the Dyson Helpline.
- For more information on how we protect your privacy, please see our privacy policy on the Dyson website.

DISPOSAL INFORMATION

- Dyson products are made from high grade recyclable materials. Recycle where possible.

